USER MANUAL

(TRAMPOLINE)



the big
bounce!
www.thebigbounce.co.nz



Check out our assembly video online.

<http://www.youtube.com/user/numberonefitnessnz>



READ THIS FIRST!!!

IN CASE OF MISSING OR BROKEN PARTS, PLEASE CONTACT PLACE OF PURCHASE FOR ASSISTANCE.

Warning: The supplier is not liable for any injuries that may occur when using the trampoline.

GENERAL SAFETY	4
SAFE USE INSTRUCTIONS.....	4
USE OF TRAMPOLINE	5
TIPS TO REDUCE THE RISK OF ACCIDENTS.....	7
ADVISORY PRECAUTIONS WHILE USING THE TRAMPOLINE	8
DANGER IDENTIFICATION	9
TRAMPOLINE ASSEMBLY	10
NET ASSEMBLY	17
ANCHOR STRAPS	21
CARE AND MAINTENANCE	22
TRAMPOLINING TECHNIQUES	25

Enclosed are the current specifications and product features available at time of printing, however, changes may be made in equipment, availability, specifications and features without notice.

GENERAL SAFETY

SAFE USE INSTRUCTIONS

BEFORE YOU BEGIN USING YOUR TRAMPOLINE: *Read and understand the information provided in this manual.* As with all physical sports and activities there is the risk of participants receiving an injury. To ensure your future enjoyment and the prevention of injury, be sure to follow appropriate safety rules and tips.

- ALWAYS CONSULT A DOCTOR/PHYSICIAN BEFORE PERFORMING ANY KIND OF PHYSICAL ACTIVITY.
- ALWAYS CHECK YOUR TRAMPOLINE BEFORE USE, PAYING SPECIFIC ATTENTION TO ALL THE BOLTS, JUMP MAT AND PAD POSITION. DO NOT USE IF ANY PARTS ARE MISSING OR LOOK LIKE THEY SHOW WEAR AND TEAR.
- ALWAYS USE THE PROVIDED SAFETY NET AND FRAME PAD WHEN USING THE TRAMPOLINE.
- ALWAYS ENSURE THAT THE TRAMPOLINE IS USED BY ONLY ONE PERSON AT A TIME. USE BY MORE THAN ONE PERSON CAN CAUSE SERIOUS INJURY.
- REGARDLESS OF THE SKILL OF THE USER THERE SHOULD ALWAYS BE KNOWLEDGEABLE AND MATURE SUPERVISION.
- Keep away object which could interfere with the user. Maintain a clear area around, above and under the trampoline.
- Learn the fundamental bounces and body positions thoroughly before trying more advanced skills.
- Stop exercising immediately should you feel unwell or if you feel pain in your joints and muscles. Dizziness is a sign of fatigue. You should stop bouncing and lay down on the ground should you feel dizzy.
- When using this trampoline ensure appropriate clothing is worn, preferably close fitting sports-wear and socks. **NEVER WEAR SHOES ON THE MAT.**
- Please be aware that because the trampoline is spring based it will allow the user to jump to a greater height than that on the ground, please bear this in mind and ensure that you are comfortable bouncing at low heights first.
- Proper assembly, care and maintenance of product, safety tips, warnings, and proper techniques for jumping on your trampoline are included in this manual for your safety and an extended product life span. All users and supervisors should therefore familiarize themselves with these instructions. Anybody who chooses to use the trampoline must be aware of their own limitations with regards to performing skills on this trampoline.
- The safety enclosure is there to prevent the user falling off the trampoline, and is not to be jumped into deliberately.
- Trampoline should be assembled on grass or BSI approved safety matting.

USE OF TRAMPOLINE

INITIALLY, you should get accustomed to your trampoline and understand how much spring is in each bounce. The focus at this point should be body position and technique until each skill can be completed with ease and control.

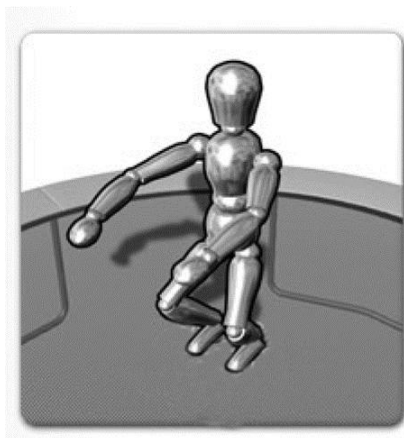

- **BEFORE YOU TRY TO JUMP TOO HIGH** the technique for stopping should be learnt as this will help prevent injury should you feel you are jumping out of control.
- As the user lands on the bed knees should be bent so that they stop and absorb the spring in the mat. The position is shown in the image to the left. Arms are held out for increased level of balance.
- This skill is used when the trampoline user wishes to stop bouncing on the trampoline due to fatigue, loss of control, etc.

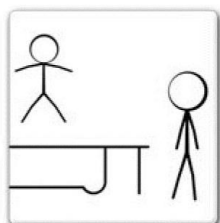

- **Only use trampoline with mature and knowledgeable supervision.**



- **Do not attempt or allow somersaults.**

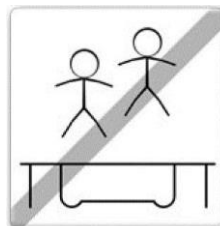

- **Do not allow more than one person on the trampoline at any time.**



- **Do not use the trampoline when wet.**

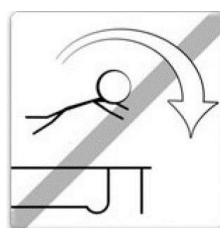

- **Do not jump onto or off the trampoline.**



- **Do not use a trampoline while under the influence of alcohol or drugs.**



- **Do not allow any activity underneath the trampoline.**

- **Inspect the trampoline before each use. Make sure the frame padding is correctly and securely positioned. Replace any worn, defective, or missing parts.**
- **Keep objects away which could interfere with the user. Maintain a clear area around, above, and under the trampoline.**
- **Learn fundamental bounces and body positions thoroughly before trying more advanced skills.**

TIPS TO REDUCE THE RISK OF ACCIDENTS

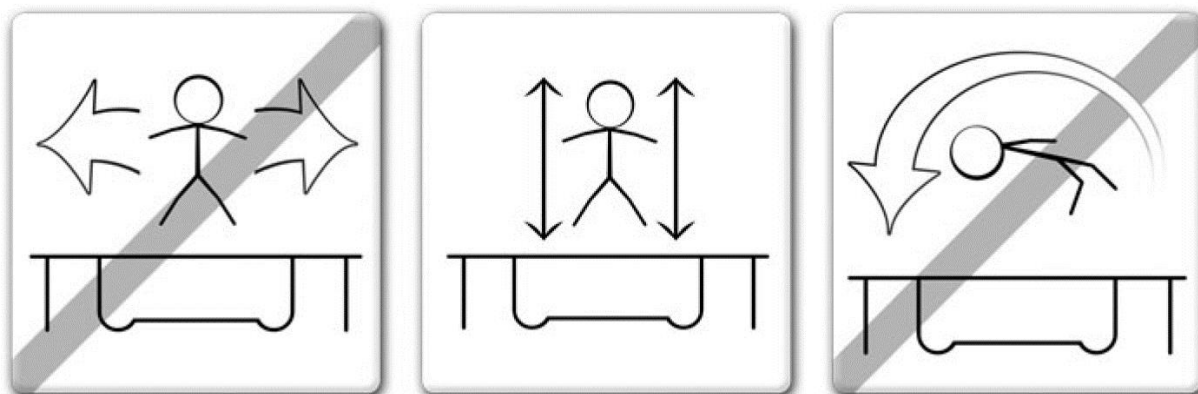

In order to reduce the risk of accident the "TRAMPOLINE USER" should:

- Always remain in control of their jumps and body position at all times.
- Not attempt to perform skills that are beyond their own level of competence.
- Read and understand the jump by taking off and landing in the middle of the trampoline.
- Always control their jump by taking off and landing in the middle of the trampoline.
- Always jump vertically and refrain from bouncing towards the springs in any direction.
- Always consult a professionally certified trampoline instructor before attempting anything beyond basic techniques.

In order to reduce the risk of accident the "**SUPERVISOR**" should:

- Fully understand and enforce all the safety rules and guidelines.
- Advise the trampoline user and provide knowledge in what they are doing right and wrong to ensure the safety of user.
- Be aware and advise the trampoline user of all the safety warnings.

IMPORTANT: If the Trampoline can not be supervised there should be a method for securing it and preventing anyone from using the product until supervision is available (e.g. Remove the access ladder or use a padlock in the net zips).

ADVISORY PRECAUTIONS WHILE USING THE TRAMPOLINE

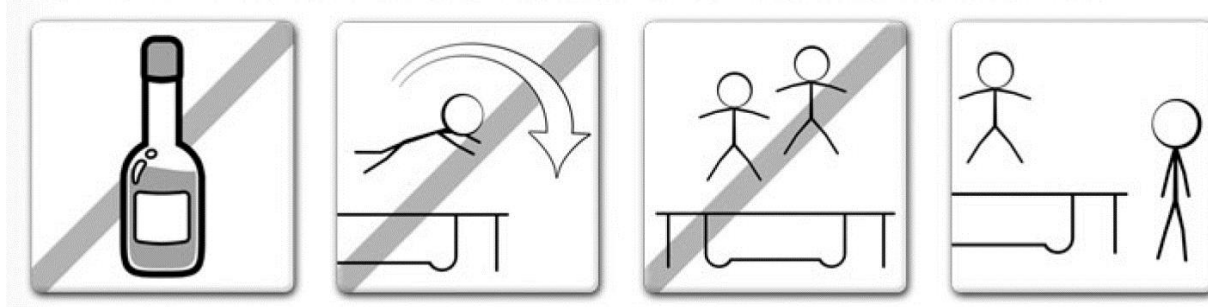

- Do not use trampoline if you have consumed alcohol or narcotic substances
- You should climb on and off the trampoline in a controlled and careful manner. Never jump onto or off the trampoline and never use the trampoline as a means to bounce onto or into another object.
- Always learn the basic bounce and master each type of bounce before trying more difficult types of bounces. Review the basic skills section to learn how to do the basics.
- To stop your bounce, flex your knees when you land on your feet.
- Always be in control when you are bouncing on the trampoline. A controlled jump is when you land at the same spot that you took off from. If at any time you feel out of control, stop bouncing immediately.
- Do not jump or bounce for prolonged periods of time or too high for a number of jumps. Keep your eyes on the mat to maintain control.
- Never have more than one person on the trampoline at a time.

IMPORTANT: Familiarise yourself with the basic jumps and safety rules .To prevent and reduce the risk of injuries, ensure that all safety rules are enforced and the new users learn the basic bounces before trying more advanced techniques .

- **ALL USERS need to be supervised, regardless of skill level or age.**
- Never use the trampoline when it is wet, damaged, dirty or worn out. The trampoline should be inspected before each use.
- Keep all objects that could interfere during use away from the trampoline at all times. Be aware of what is overhead, underneath and around the trampoline.
- To prevent unsupervised and unauthorized use, the trampoline should be secured when unattended by the owner or supervisor.

DANGER IDENTIFICATION**MOUNTING AND DISMOUNTING:**

Be very careful when getting on and off the trampoline. DO NOT mount the trampoline by grabbing the frame pad, stepping onto the springs or by jumping onto the mat of the trampoline from an object (e.g. a deck, roof, or ladder). This is considered highly dangerous. DO NOT dismount by jumping off the trampoline and landing on the ground. If small children are playing on the trampoline they may need help in mounting and dismounting.

**USE OF ALCOHOL OR DRUGS:**

DO NOT consume any alcohol or take any drugs (*this includes medication that could affect the users co-ordination*) when using this trampoline. This is considered highly dangerous since these foreign substances impair your judgments, reaction time and overall physical co-ordination.

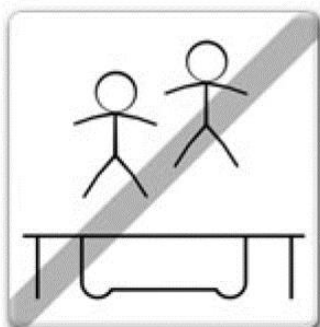
**MULTIPLE USERS:**

If you have multiple users (more than one person on the trampoline at any one time), you increase the chance of being injured. Injuries can occur when you fly off the trampoline, lose control, collide with other jumper(s), or land on the springs.

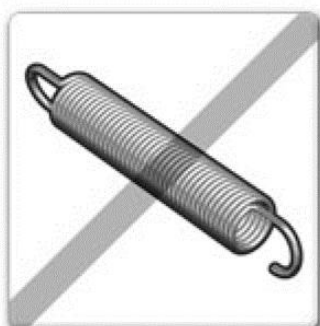
**STRIKING THE SPRING FRAME:**

When playing on the trampoline, STAY in the centre of the trampoline mat. This will reduce the risk of being injured by landing on the spring frame. Always keep the frame pads covering the frame of the trampoline. DO NOT jump or step onto the frame pad directly since it is not intended to support the weight of a person.

**LOSS OF CONTROL:**

DO NOT try difficult maneuvers until you have mastered the basics. If you do not follow these guidelines, you increase the risk of someone being injured.

TRAMPOLINE ASSEMBLY

Check out our assembly video online:

<http://www.youtube.com/user/numberonefitnessnz>



To assemble this trampoline all you need are the tools provided, including our special spring tool. During periods of non-use this trampoline can be easily disassembled and stored.

Please read the assembly instructions before beginning to assemble the product.

Please refer to the table below for part descriptions and numbers. The assembly instructions use these descriptions and numbers as reference.

Before you start assembling make sure you have all parts listed. If you are missing any parts, please contact our customer service team.

Please use gloves to protect your hands from pinch points during assembly. When you are ready to start, make sure that you have plenty of space and a clean dry area for assembly

SITING INSTRUCTIONS

- Adequate overhead clearance is essential. A minimum of 8 m from ground level is recommended. Allow clearance for wires, tree limbs, and any other possible hazards.
- Place the trampoline away from walls, structures, fences, and other play areas.
- Maintain a free space of 1.5 m on all sides of the trampoline. This area should not include concrete, bitumen, brick or other hard surfaces as these can cause serious injuries.
- Keep the trampoline on a level surface.
- Use the trampoline in a well-lighted area.

PARTS LIST

Ref. Number	Part Number	Description	Unit	8'	10'	12'	14'	16'
1	TR800	Trampoline Mat, stitched with D-Rings	Pcs	1	1	1	1	1
2	TR801	Frame Pad	Pcs	1	1	1	1	1
3	TR802	Top Frame with leg sockets	Pcs	6	8	8	8	12
4	TR803	Leg Base	Pcs	3	4	4	4	6
5	TR804	Leg Extension	Pcs	6	8	8	8	12
6	TR805	Springs	Pcs	48	64	72	96	108
7	TR806	Safety Instruction Placard	Pcs	1	1	1	1	1
8	TR807	Spring tool	Pcs	1	1	1	1	1
9	TR808	Bolt Pack	Pcs	12	16	16	16	24
10	TR809	T Connector	Pcs	6	8	8	8	12

Enclosed are the current specifications and product features available at time of printing, however, changes may be made in equipment, availability, specifications and features without notice.

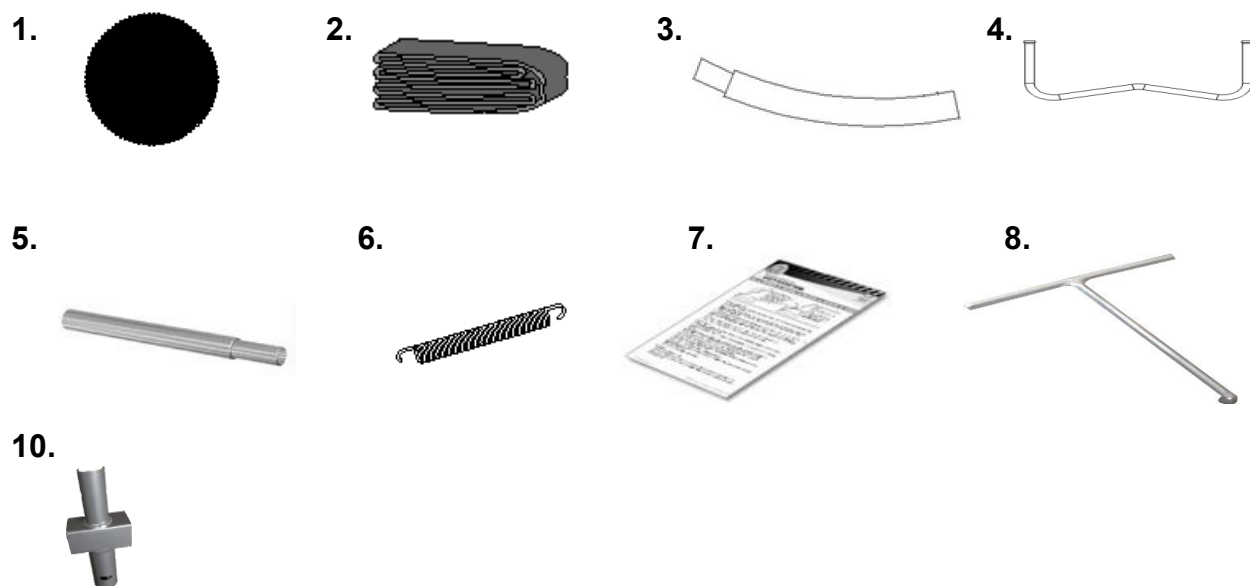

Frame layout

Lay out all the frame parts as shown in the pictures below.

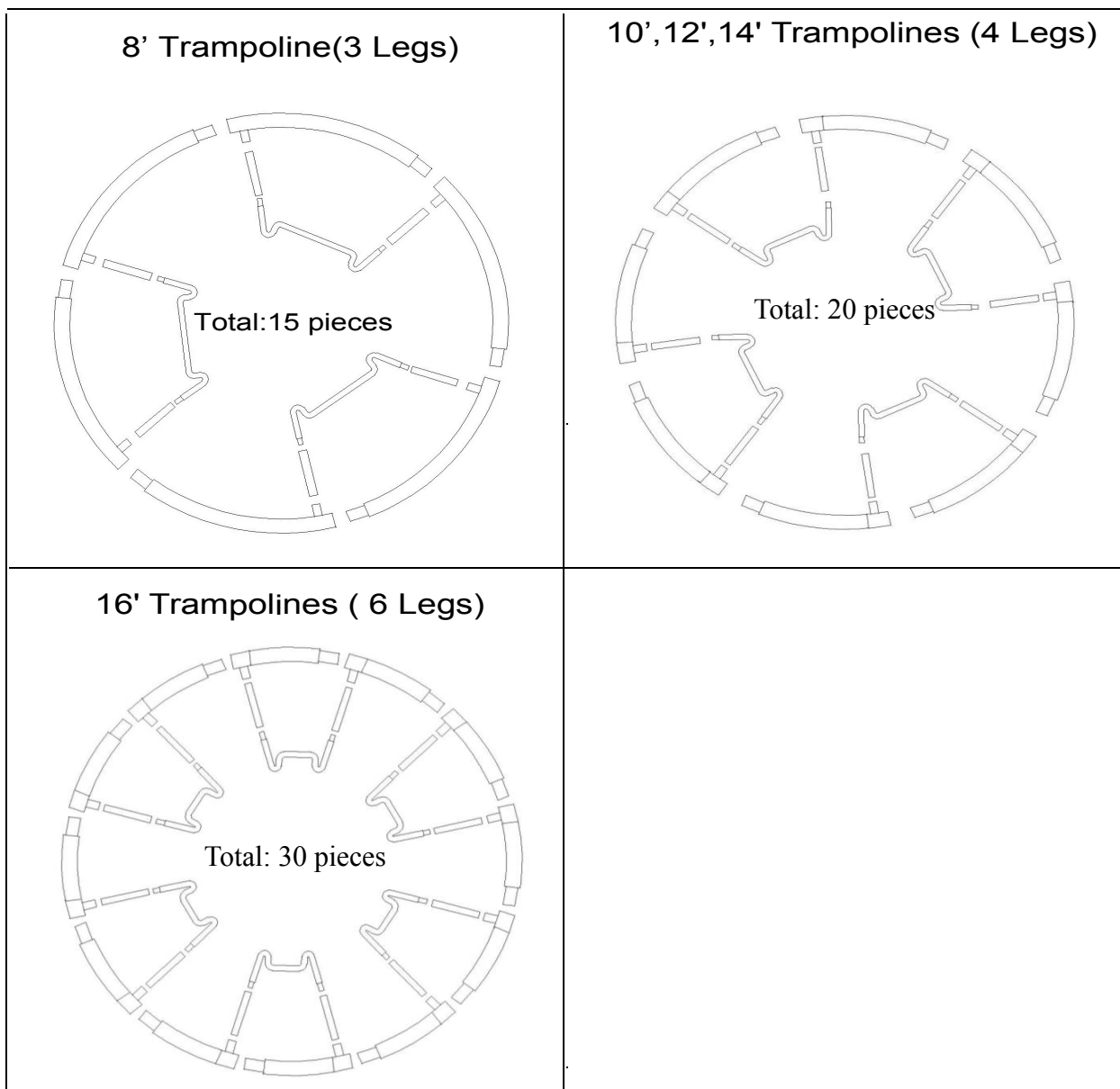

ASSEMBLY TIPS

- ☒ **Assembly should only be done by adults.**
- ☒ **Minimum of two people are needed for the assembly**
- ☒ **You will need an area large enough to turn the trampoline frame over**
- ☒ **For a video of Trampoline assembly please visit our YouTube channel to view assembly of the Big Bounce Trampoline**

<http://www.youtube.com/user/numberonefitnessnz>



STEP 1: - Top Frame and Leg Extension Assembly

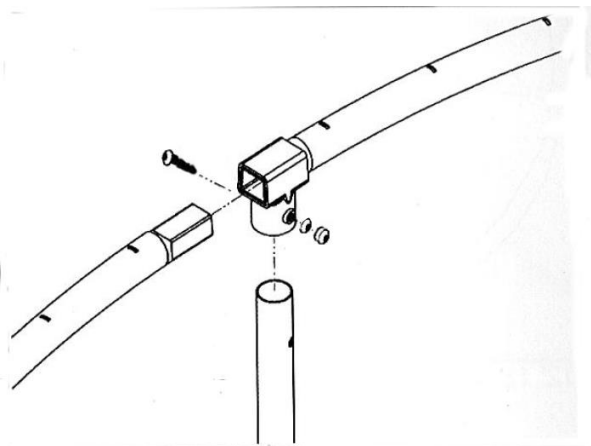

FIG 1

- Using one T Connector (TR809) connect two frame pieces (TR802).
 - Insert one leg extension pole (TR804) into each leg socket in the T Section. Secure extension pole using a bolt washer and nut
- PLEASE NOTE: If you have purchased the additional basketball hoop accessory you will need to substitute one of the T-Connectors supplied with the trampoline for the Basketball T-Connector**

STEP 2: Leg Base Assembly

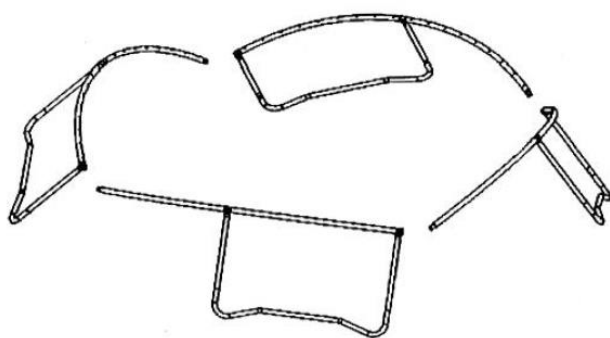

FIG 2

- On the end of the frame assembly made in step one install another T Connector and Leg Extension pole.
 - Insert a leg base (TR803) into the leg extensions. It should now look like one of the sections in the image to the left. Secure the leg base using a bolt washer and nut
- Lay the sections out as shown in Fig 2.
 - **From this point two people are needed** to finish putting the frame together as below.

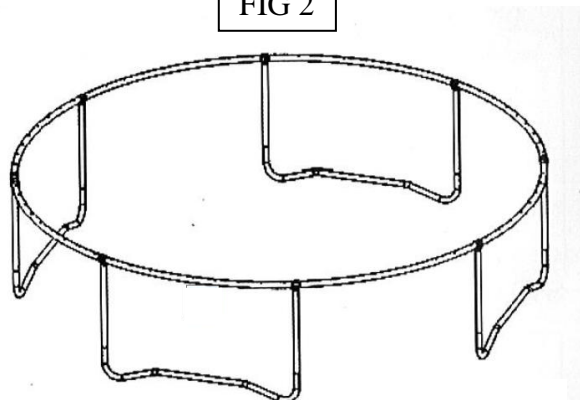

FIG 3

STEP 3: Trampoline Mat Assembly

WARNING: While attaching springs, the connection between the frame pieces can become pinch points as the mat and springs tighten the frame connections. With this in mind please be careful attaching springs to the trampoline mat.



Layout the **Trampoline Mat** (TR800) inside the frame on the ground as picture above.

STEP 4: ATTACHING THE SPRINGS TO TRAMPOLINE MAT

To install the mat the tension needs to be evenly applied. The diagram on the right shows the position of the first four springs to be connected. The table below shows the corresponding location of the springs depending on trampoline size

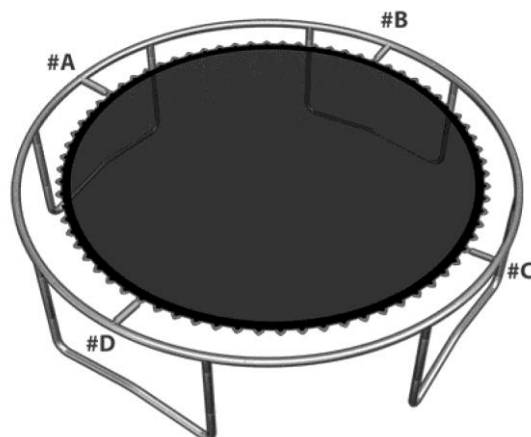

Trampoline	#A	#B	#C	#D
8 FT trampoline	1	12	24	36
10FT trampoline	1	16	32	48
12FT trampoline	1	18	36	54
14FT trampoline	1	24	48	72
16FT trampoline	1	27	54	81

HOW TO USE THE SPRING TOOL

Firstly hang one side of spring on the triangle (D Link) attached to the trampoline mat (TR800), and use the spring tool (TR807) to hook the other side of spring (As shown in the top image to the right).

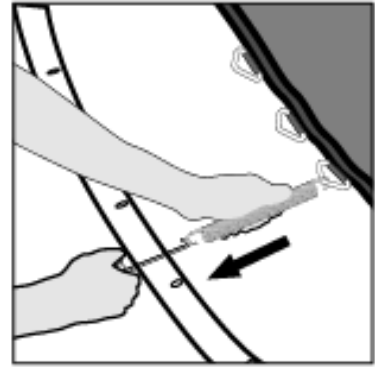

Pull the Spring Tool until the spring hook inserts into the hole on the top frame then disengage the spring tool. Repeat process for all springs.

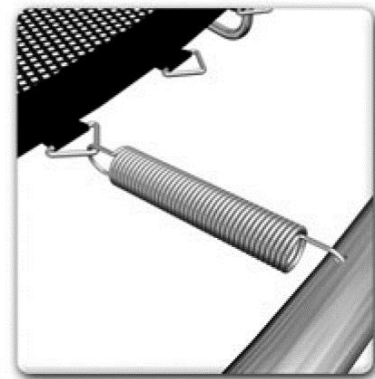

WARNING!! : Please be careful where your hands and other parts of the body are placed as the connector points and spring attachments can cause injury.

STEP 5 - Safety Placard Attachment

- A. Using the tie wrap, attach the Safety Instruction Placard (7) to the trampoline. The tie wrap should go around the Vertical Frame joint and the Top Rail to ensure that it doesn't slide off the trampoline.

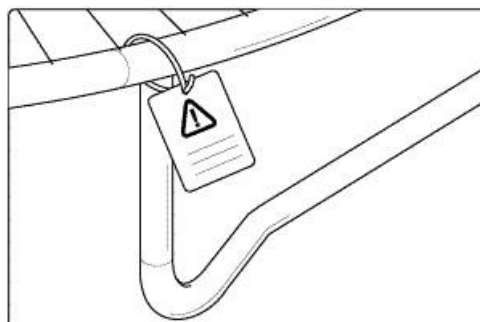

STEP 6-Frame Pad Assembly

IT IS ESSENTIAL THE FRAME PADS ARE ATTACHED TO THE TRAMPOLINE CORRECTLY PRIOR TO USE

- A.** Lay the Frame Pad (2) over the trampoline so that the springs and steel frame are covered. There are holes in the pad which line up with the tubing coming out the top of the T Connectors. Push the pad down carefully over these.
- B.** Tie the elastic straps located at the under side of the frame pad to the outer frame.

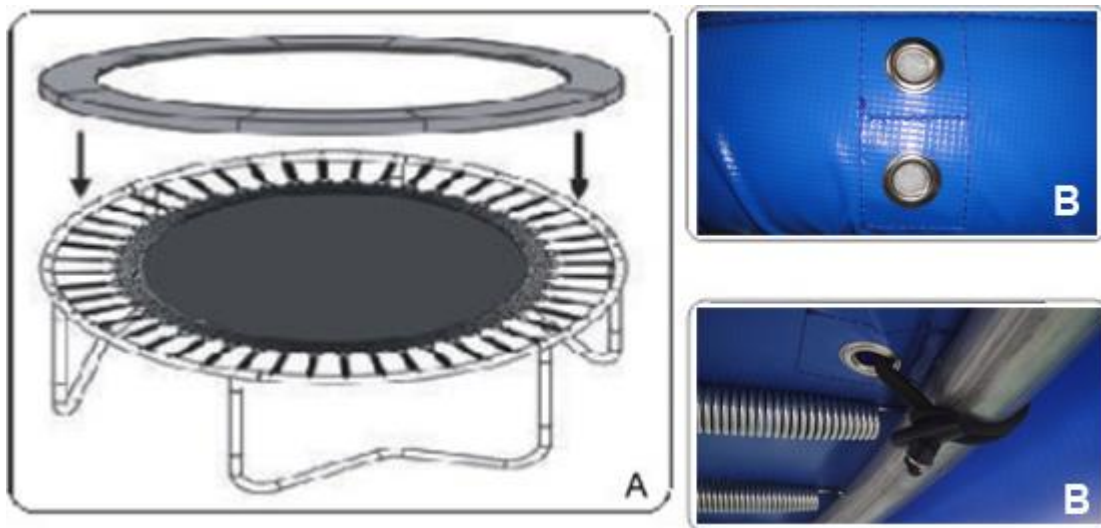

- C.** Tie elastic tape located at the underside of frame pad to the nearest spring.



NET ASSEMBLY

Ref. Number	Part Number	Description	Unit	8'	10'	12'	14'	16'
1	TR810	Bottom tube	Pcs	6	8	8	8	12
2	TR811	Top tube	Pcs	6	8	8	8	12
3	TR812	Top cap	Pcs	6	8	8	8	12
4	TR814	Net	Pcs	1	1	1	1	1
5	TR815	Fiberglass Rod	Pcs	8	10	12	14	16
6	TR816	Galv. Connector	Pcs	8	10	12	14	16

STEP 1 -Net Pole Assembly

- A. Connect the bottom tube and top tube. Insert these into the black PVC sleeve (see pictures)

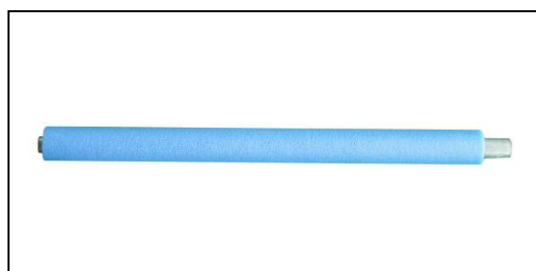

Bottom tube

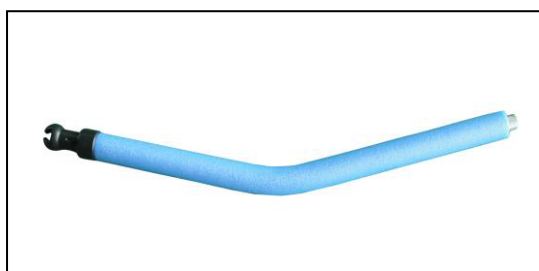

Top tube



Connecting two tubes



Black PVC sleeve

- B. Clip each of the pole assemblies into the T sections on the trampoline.

STEP 2 - Top Ring Assembly

- A. Assemble two even lengths of fiberglass rods using the galvanised connectors as shown below

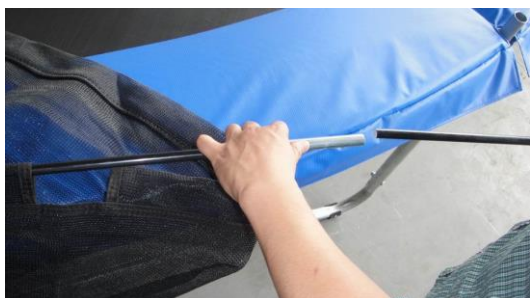

- B. Lie the net flat as shown



- C. Run the two even lengths of the rods through the loops at the top of the net



- D. Have one person stand on two of the ends of the rods while someone else pushes forward and connects one side of the net as per picture



- E. To make the last connection have one person stand on the opposite side. Push the rods towards the centre of the ring until they are in line with each other and make the last connection. Picture below.



STEP 4 – Securing Net.

A. Raise the net up into position and clip the ring into the Top Caps



Top Cap



B. Starting by the door connect one loop to a spring as per the picture below this is point A

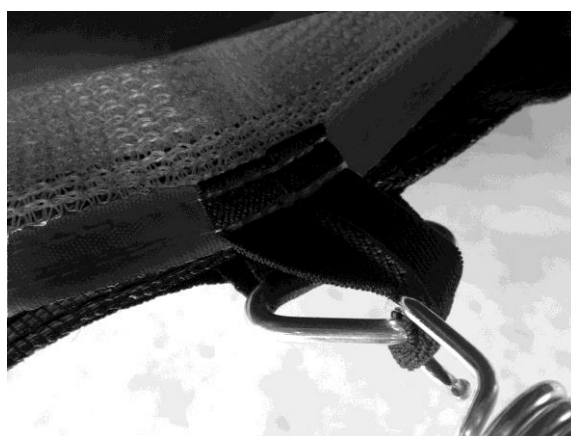

Using the table and graphic below count the number of loops and springs attach loops at points B, C and D. This evenly spreads the tension across the net.

Trampoline	#A	#B	#C	#D
8 FT trampoline	1	12	24	36
10FT trampoline	1	16	32	48
12FT trampoline	1	18	36	54
14FT trampoline	1	24	48	72
16FT trampoline	1	27	54	81

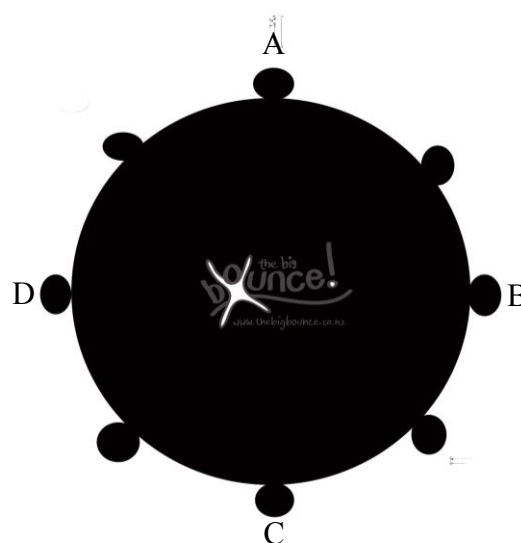

C. The rest of the loops may now be attached to the end of the springs.

ANCHOR STRAPS

The anchor straps are used to assist in preventing the trampoline blowing away in high winds. When choosing a site for the trampoline, care should be taken that it is in an area where there is as much shelter as possible.

Please note: *In open areas where the trampoline could be exposed to extremely high winds additional precautions should be undertaken to prevent damage to the trampoline including removing the safety net and moving the trampoline to a more sheltered area.*

Included with the trampoline are two anchor straps and two anchors. Additional anchor kits can be purchased separately.



Instructions for installation.

For each anchor you will need to screw the anchor into the ground directly below the frame where you wish to secure the strap. The anchor needs to be turned clockwise and it will bury itself into the ground. You should continue until only the top ring of the anchor is showing. If you have particularly hard soil you may wish to use a peg through the top ring to gain some leverage which will assist in screwing the anchor all the way in. Once the anchor has been placed use the straps to secure the frame to the anchor. The large part of the strap goes over the top frame rail of the trampoline and is secured using the guide below. It is easier to first secure the small strap to the ring in the top of the anchor and then secure the large strap over the frame. The result should look something like the picture below (Note: Excess strap has been tied off above the buckle)

Free End of strap comes through from this edge.

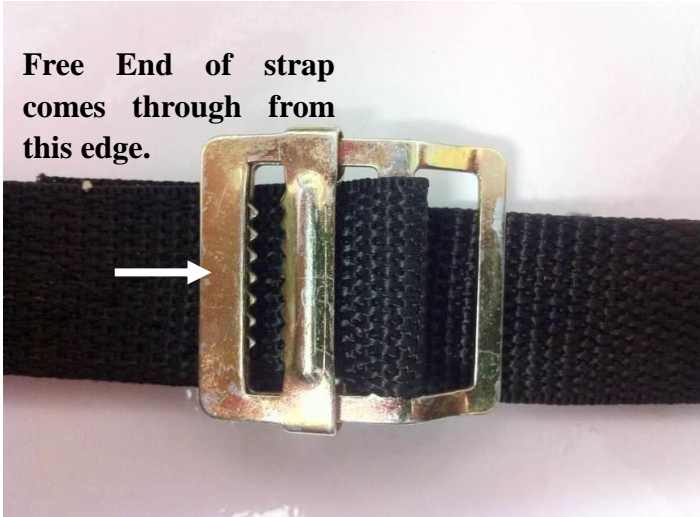

Pull free end through under first edge of buckle over the centre and then under the last side of the buckle.

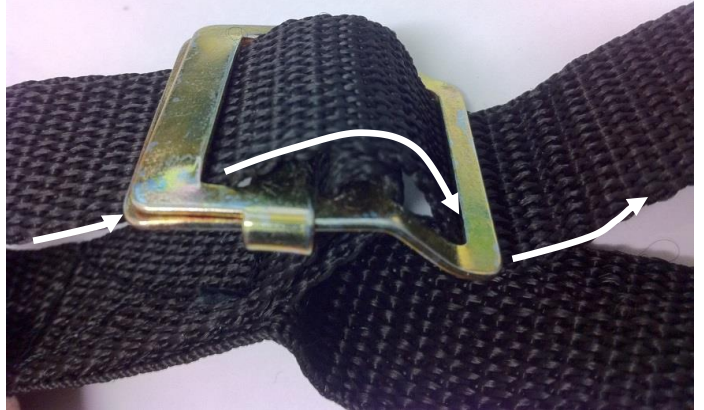

After pulling the strap tight feed the free end over the buckle and under the last edge of buckle as pictured



CARE AND MAINTENANCE

This trampoline was designed and manufactured with quality materials and craftsmanship. If proper care and maintenance is provided, it will provide all jumpers with years of exercise, fun, and enjoyment as well as reduce the risk of injury. Please follow the guidelines listed below:

This trampoline is designed to withhold a certain amount of weight and use. Please make sure that only one person at any one time uses the trampoline. Jumpers should either wear socks, gymnastics shoes, or be barefoot when using the trampoline. Please be aware that street shoes or tennis shoes should NOT be worn while using the trampoline. In order to prevent the trampoline mat from getting cut or damaged please do not allow any pets onto the mat. Also, jumpers should remove all sharp objects from their person prior to using the trampoline. Any type of sharp or pointed objects should be kept off the trampoline mat at all times. Cigarette ends, fireworks and open fires should be kept well away from trampolines as they can very easily cause damage to both the jump mat and safety net

Always inspect the trampoline before each use for worn, abused or missing parts. A number of conditions could arise that may increase your chances of getting injured. Please be aware of:

- Punctures, holes, or tears in the trampoline mat
- Sagging trampoline mat
- Loose stitching or any kind of deterioration of the mat
- Bent or broken frame parts, such as the legs
- Broken, missing, or damaged springs
- Damaged, missing, or insecurely attached frame pad
- Protrusions of any types (especially sharp types) on the frame, springs, or mat

Over time if you find that surface rust appears it should be removed with a wire brush or coarse sandpaper and then treated with a cold galvanizing spray (readily available at hardware stores)

IF YOU FIND ANY OF THE PREVIOUS CONDITIONS, OR ANYTHING ELSE THAT YOU FEEL COULD CAUSE HARM TO ANY USER, THE TRAMPOLINE SHOULD BE DISASSEMBLED OR SECURED FROM USE UNTIL THE CONDITION(S) HAS BEEN RESOLVED.

WINDY CONDITIONS

In severe wind situations, the trampoline can be blown about. If you expect high wind conditions, the trampoline should be moved to a sheltered area or disassembled. Another option is to tie the round, outside portion (top frame) of the trampoline to the ground using ropes and stakes. To ensure security, at least three extra tie downs should be used.

MOVING THE TRAMPOLINE

Should the need arise to move the trampoline, two people are required. All connector points should be wrapped secured with weather resistant tape, such as duct tape. This will keep the frame intact during the move and prevent the connector points from dislocating and separating. When moving, lift the trampoline slightly of the ground and keep it horizontal to the ground. For any type of other move, you should disassemble the trampoline.

TRAMPOLINING TECHNIQUES

BASIC SKILL 1: The Basic Bounce

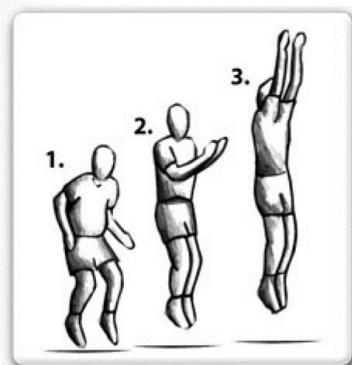

- Start from a standing position, with feet shoulder width apart head up and eyes on the trampoline bed.
- Swing arms forward and up above head in a circular
- Bring legs and feet together in " mid-air " position and point toes.
- Land back on the mat with feet shoulder width apart (same as start position).
- Why not try moving onto the next skill once comfortable and proficient.

BASIC SKILL 2: The Knee Drop

- Start with a low basic bounce (as above)
- Land on knees shoulder width apart, keeping back straight and a strong body position using arms out to the side or in front to maintain balance.
- Bounce back to basic bounce position by using bounce momentum and swinging arms above head.
- Once mastered at this height try bouncing a little higher, but remember to always stay in control of your height.



BASIC SKILL 3: The Seat Drop



- Start with a low basic bounce (BASIC SKILL 1) in the normal position.
- Land with legs out straight in front of you, with hands either side of your hips and back straight in a strong body position.
- Use the bounce momentum aided with a push from hands to return to a standing position.
- Once mastered at this height try bouncing a little higher, but remember to always stay in control of your height.

BASIC SKILL 4: Hands and Knees Drop

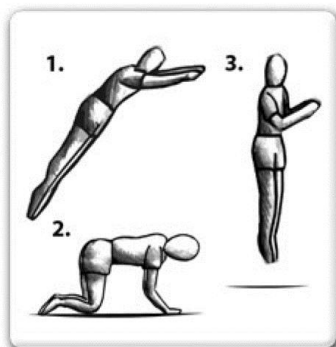

- Start with a low basic bounce (BASIC SKILL1) in the normal
- Land on your hands and knees at the same time, ensure that back is horizontal to the bounce mat and hands & legs are shoulder width apart also.
- Use the momentum of bounce and push off hands to regain the standing position.
- Once mastered at this height try bouncing a little higher, but remember to always stay in control of your height.
- Try moving onto the next skill once comfortable and

BASIC SKILL 5: Front Drop

- Land on your hands and knees at the same time, ensure the back is horizontal to the bounce mat and hands & legs are shoulder width apart also.
- Maintain strong body position with back horizontal to mat and straighten legs behind and fold arms in front of face in mid-air ready to land on the mat in a lying
- Ensure the landing is done with all of body touching the mat at same time.
- Push off hands and recover the standing position.
- Once mastered at this height try bouncing a little higher, but remember to always stay in control of your height. Trying moving onto the next skill once comfortable and proficient.

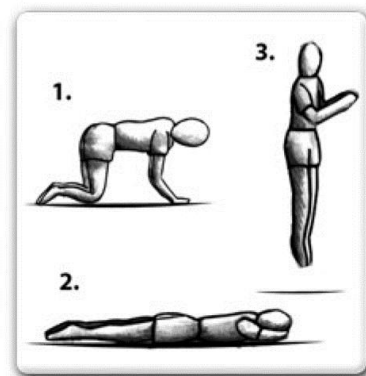

IMPORTANT: Should you wish to progress any further and learn more advanced techniques for trampoline, please consult a qualified and registered instructor.