

~~PRO~~RUNNER

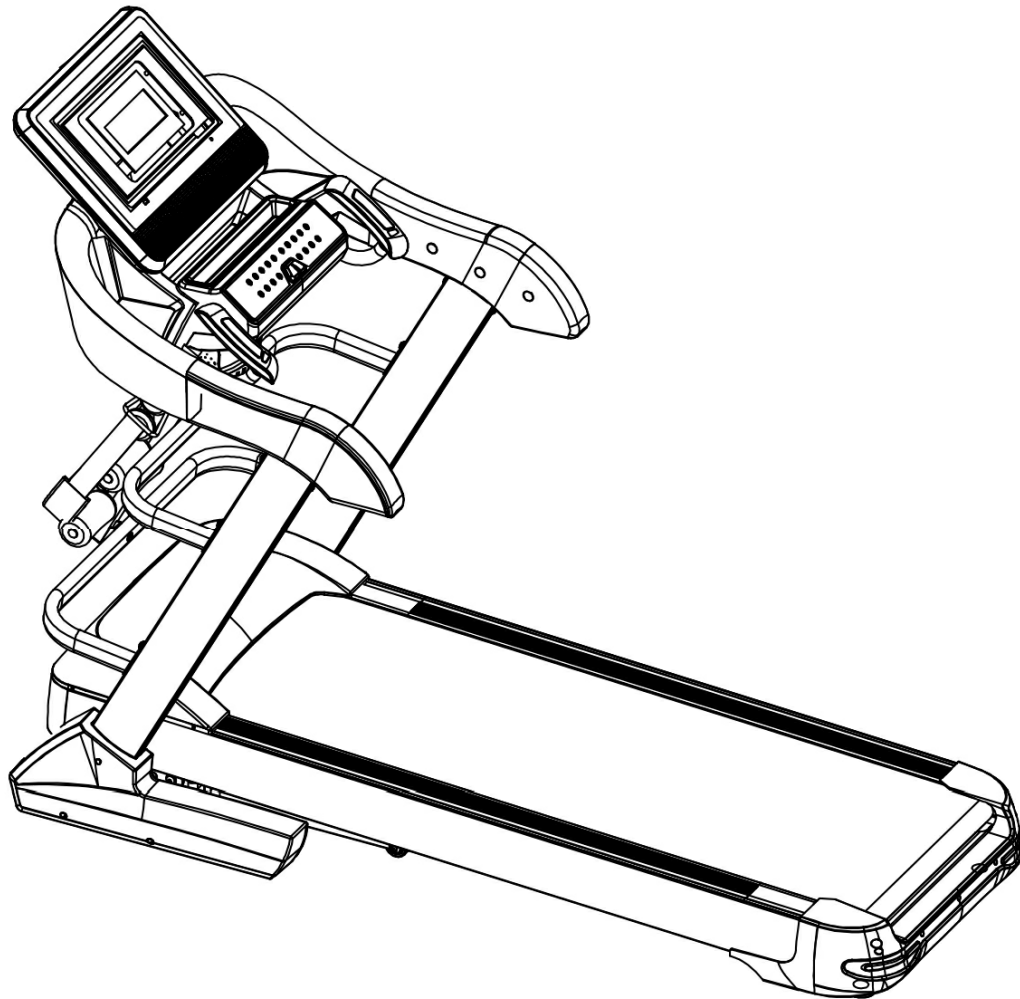

OWNER MANUAL

ELITE TREADMILL QRS7-10

SKU: JV03TNNABXXXXX

TABLE OF CONTENTS

Quality Guarantee Commitment	3
Safety Instructions	4
Special Safety Instructions	5
Assembly Description	5
Explosion Diagram	7
Explosion Details	8
Assembly Steps	10
Operating Instructions	12
Panel Instructions	15
Refueling Oil Process	39
Running Belt Adjustment	40
Considerations	43

QUALITY GUARANTEE COMMITMENT

Thank you for purchasing this product. It will improve your health.

We ensure that this product is made from high-quality materials. In the event of a problem with the product during regular use, we will repair it.

Warranty period is one year (from the date of purchase). If the product you purchase has quality problems, please contact our customer service personnel in 12 months. Please, do not attempt to resolve the issue without our permission. We are responsible for repairing the following accessories: frames, wires, armrest foam, motors, moving wheels, etc. The following cases are not covered by our warranty:

- Damage for external reasons.
- Use of non-original accessories.
- Handle incorrectly by yourself.
- Fail to operate as instructed.

Quick-wear parts will not be repaired or replaced if typically worn, such as running belts.

This quality guarantee commitment is only valid for private use by family, and it does not apply to the gym and other professional training situations.

To purchase accessories beyond the scope of the warranty, please contact our customer service department. Please provide the following information when ordering:

- Address
- Treadmill's model
- The serial number of accessories.
- Proof of purchase where the date can be identified.

Please don't send the product to our company before our customer service personnel confirm. We will not bear any costs if the product is returned without our permission.

SAFETY INSTRUCTIONS

The design and manufacture of the product take many safety problems into account, but it is always advisable to follow these operating instructions. We are not responsible for any consequences caused by irregular operations.

1. Please carefully read the operating instructions manual before use to ensure your safety and prevent accidents. When training with the product, please consider your physical condition and train appropriately and regularly to ensure that you have enough physical strength. Exercise performed incorrectly, or excess training will be harmful to your health.
2. This product is unsuitable for children. People who are unwell, mentally deficient, or lack common sense shall not use this product unless under the guardianship of someone responsible for their safety. Children shall not be allowed to manipulate the equipment in any way.
3. This product is suitable for home use only.
4. This product's heart rate display does not provide data for clinical medicine.
5. The manufacturer or professional maintenance personnel must replace a damaged power line to prevent danger.
6. Please inspect all components and ensure that screws and nuts are tightened before use.
7. Please wear comfortable tight clothes when using the product to prevent the clothes from being hooked by the machine. Do not let kids or pets play nearby while using the product to avoid accidents.
8. Please place the product on a smooth, clean and flat surface. Ensure that there is nothing sharp nearby and keep it away from water and heat sources.
9. Do not touch any moving parts with your hands or place your hands or feet in a gap beneath the running belt.
10. This product can only be used by one person at a time.
11. Ensure that screws and bolts are tightened after the assembly of the product.
12. This product is an HC product. The weight of the user should not be more than 150kgs.
13. "WARNING! Heart rate monitoring systems may be inaccurate. Over exercising may result in serious injury or death. If you feel faint, stop exercising immediately".
14. Maximum allowed running surface lateral positions
15. If applicable, the value of the A-weighted emission sound pressure level at the trainer's ear;
16. The following statement: "Noise emissions under load are higher than without load."
17. The running belt has a maximum lateral movement distance of 12mm. If the yellow mark on one side of the front running board is completely exposed, it means that there is a deviation in the belt. As a result, it is necessary to adjust the running belt's center.

SPECIAL SAFETY INSTRUCTIONS

POWER SOURCE

- Place the treadmill where the power line can reach the socket.
- Directly insert the power line into the socket and keep it firm.
- Please use qualified sockets to avoid significant danger. If the plug and socket are incompatible, ask the electrician to deal with it instead of moving the plug.
- 220V—240VAC power source should be used.
- Please keep the power line away from the roller, do not place the power source on the running belt or use a damaged plug.
- Please pull the plug out from the socket before cleaning and maintenance.

Warning: failing to pull out the plug may cause personal injury and damage to equipment.

- Please inspect each component before use.
- Please do not use this product outdoors, at high humidity, or in the sun.
- Please turn off the machine and pull out the plug when you have finished the workout.







ASSEMBLY DESCRIPTION

- Please carefully read the assembly steps before installing the equipment.
- Remove all packages from wrappings and place them where is most convenient for you so that you can check and install
- Carefully check that all components are complete according to the packing list.
- Please pay attention to safety when using tools or handling. During assembly, don't force the installation.
- Please confirm whether the tools and packing materials left are dangerous
- Be aware that plastics and foam can harm children.

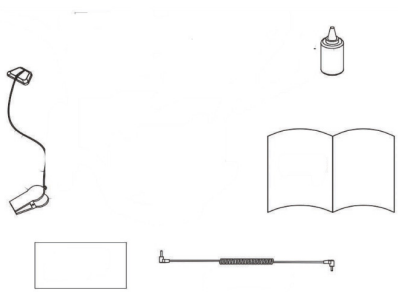
Assemble the product according to the instruction. Please carefully read the steps and description of assembly. The product must be carefully installed by adults or by professionals if necessary.

Warning: Ensure that the product is installed correctly without causing damage.

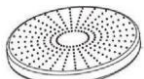
ACCESSORIES LIST

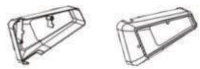
ACCESSORIES			MULTI FUNCTION	SINGLE FUNCTION
	Treadmill Machine		✓	✓
Manual Package	Mp3 Connection Line		✓	✓
	Security Lock			
	Silicone Oil			
	Instruction Manual			
	Screw Package			
Multifunctional Accessories	Massage Bracket		✓	✗
	Sit-up Bracket		✓	✗
	Massage Head		✓	✗
	Sponge Jacket		✓	✗
	Body Twister		✗	✗
	Dumbbell		✗	✗
	Left and Right Side Covers		✓	✓

EXPLOSION DIAGRAM

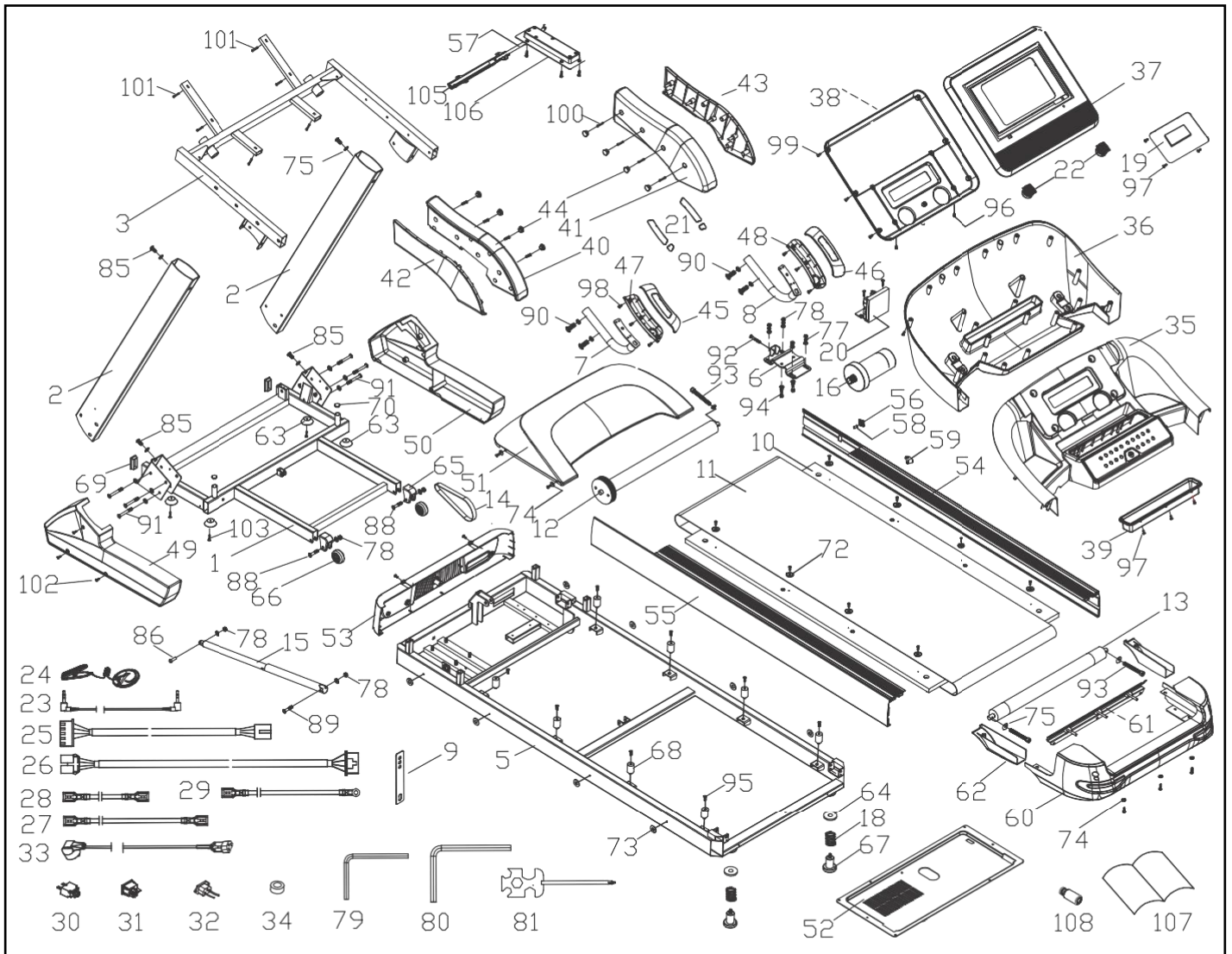
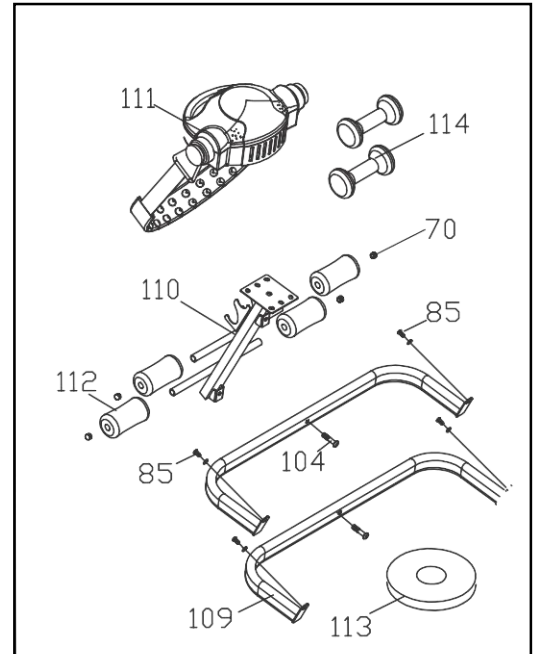
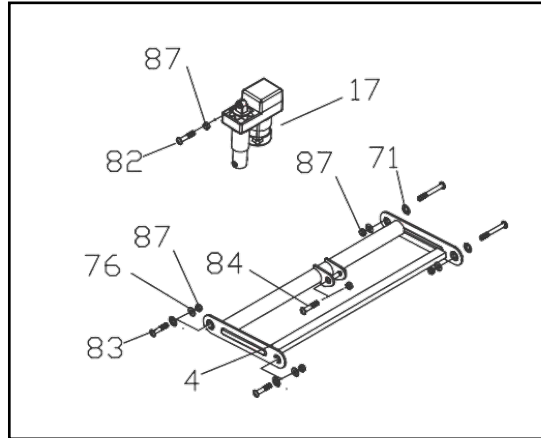

EXPLOSION DETAILS

NO.	NAME	QTY
1	Base	1
2	Left Column	1
3	Right Column	1
4	Incline Frame	1
5	Main Frame	1
6	Motor Base	1
7	Small Armrest (Left)	1
8	Small Armrest (Right)	1
9	Package Stator	1
10	Running Deck	1
11	Running Belt	1
12	Front Roller	1
13	Rear Roller	1
14	Motor Belt	1
15	Gas Spring	1
16	DC Motor	1
17	Incline Motor	1
18	Compressed Spring	1
19	Electronic PCB	1
20	Controller	1
21	Holding Heartbeat	2
22	Incline	2
23	Mp3 Connecting Line	1
24	Safety Key	1
25	Upper Line Of Electronic Meter	1
26	Lower Line Of Electronic Meter	1
27	150mm Single Branch Line	2
28	300mm Single Branch Line	2
29	300mm Grounding Wire	1
30	Overload Protector	1

NO.	NAME	QTY
31	Power Switch	1
32	Socket	1
33	Power Line	1
34	Magnetic Ring	1
35	Electronic Meter Top Cover	1
36	Electronic Meter Lower Cover	1
37	Electronic Board	1
38	Panel Back Cover	1
39	Bottle Cage	1
40	Left Armrest Foaming	1
41	Right Armrest Foaming	1
42	Left PU Outer Cover	1
43	Right PU Outer Cover	1
44	Plastic Hole Cover	8
45	Left Small Armrest Cover	1
46	Right Small Armrest Cover	1
47	Left Small Armrest Back Cover	1
48	Right Small Armrest Back Cover	1
49	Left Side Cover	1
50	Right Side Cover	1
51	Motor Cover	1
52	Motor Lower Cover	1
53	Motor Front Cover	1
54	Plastic Edge Strip	2
55	Side Rail	2
56	Silicone Oil Tank	1
57	Fuel Pip	2
58	Tubing Bushing	1
59	R Type Line Buckle	4
60	End Cap	1

EXPLOSION DETAILS

NO.	NAME	QTY
61	End Cap Inner Cover	1
62	End Cap Side Cover (L/R)	2
63	Adjustment Foot Pad	4
64	Rubber Gasket	2
65	Moving Roller Sleeve	2
66	Moving Roller	2
67	Adjustment Foot Pad	2
68	Round Cushion	8
69	Square Tube Plug	5
70	Round Inner Tube Plug	2
71	Plastic Spacer	6
72	Side Buckle	8
73	Thickened Side Buckle	8
74	M4 Flat Pad	7
75	M8 Flat Pad	38
76	M10 Flat Pad	6
77	M8 Spring Pad	6
78	M8 Locknut	14
79	M5 L-Shaped Hex Wrench	1
80	M6 L-Shaped Hex Wrench	1
81	Cross Open End Wrench	1
82	Half-Round Head Hexagon Screws M10* 40	1
83	Half-Round Head Hexagon Screws M10* 25	4
84	Half-Round Head Hexagon Screws M10* 55	1
85	Hexagon Socket Head Cap Screws M8* 20	10
86	Half-Round Head Hexagon Screws M8* 25	1
87	M10 Locknut	6
88	Half-Round Head Hexagon Screws M8* 40	2

NO.	NAME	QTY
91	Half-Round Head Hexagon Screws M8* 65	6
92	Half-Round Head Hexagon Screws M8* 70	1
93	Half-Round Head Hexagon Screws M8* 60	3
94	Half-Round Head Hexagon Screws M8* 12	2
95	Half-Round Head Hexagon Screws M8* 25	8
96	Cross Flat Head Screw M5* 30	4
97	Cross Washer Head Self Tapping Screw ST3.0* 10	14
98	Phillips Head Self-Tapping Screws ST4.0* 16	6
99	Cross Semicircular Head Self Tapping Screw ST4.0* 16	59
100	Phillips Head Self-Tapping Screws ST4.0* 25	8
101	Phillips Head Self-Tapping Screws ST4.0* 30	6
102	Phillips Pan Head Self-Drilling Self-Drilling Screw ST4.0* 16	39
103	Phillips Pan Head Self-Drilling Self-Drilling Screw ST4.0* 25	6
104	Hexagon Socket Head Cap Screws M8* 30	2
105	Oil Cap	1
106	Fuel Tank	1
107	Instruction Manual	1
108	Silicone Oil	1
109	Massage Machine Bracket	2
110	Supine Support	1
111	Massage Head	1
112	Sponge	4
113	Twister	1
114	Dumbbell	2

ASSEMBLY STEPS

ASSEMBLING OF ELECTRONIC METER

1. Hold the column and slowly put it into the fixing screw hole.
2. Secure the column to the base with M8x20 screws, M8x65 screws and M8 flat washers.
3. Fix the electronic meter on the column with M8x20 screws and M8 flat washers.

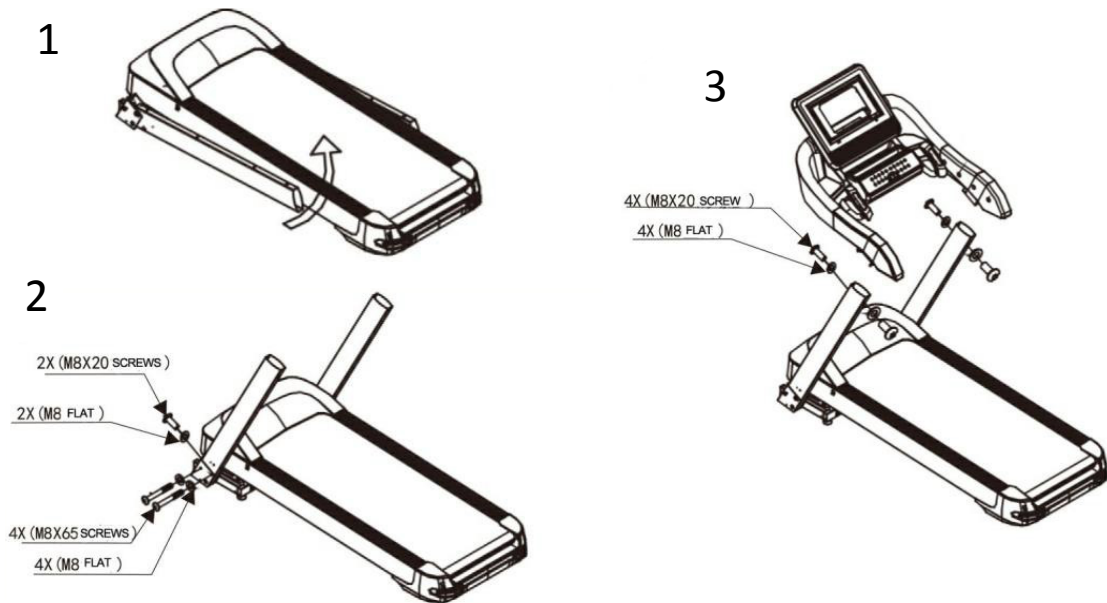

COLUMN AND LEFT AND RIGHT SIDE COVER ASSEMBLY

1. Remove the package stator between the fixed frame and base, taking care not to hurt yourself when the frame is bounced.
2. Use the 4.2*16 screws to fix the left and right side covers to the sides of the base.

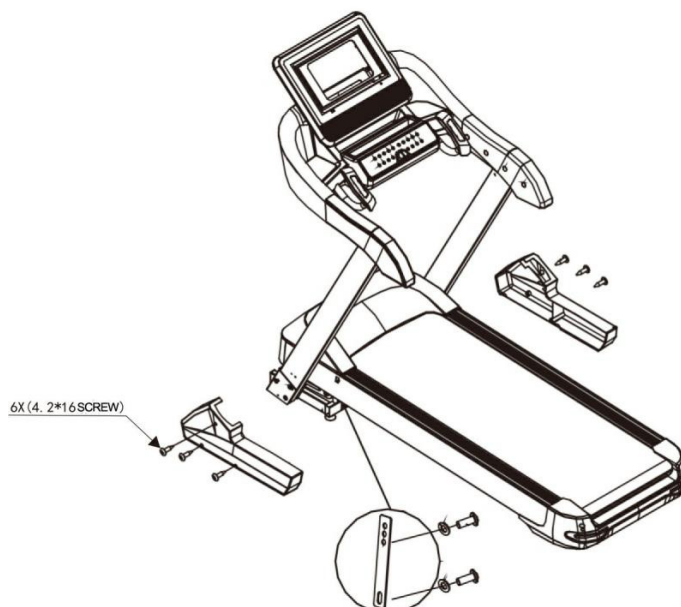

ASSEMBLING OF MULTI-FUNCTION

1. Remove the massage machine bracket, pay attention to the (L) and (R)[®] marks, and fix the massage machine bracket to the left and right columns with the M8*20 screw and M8 flat washer.
2. Remove the supine support and fix the supine support on the massage support bracket with M8*30 screws and an M8 flat washer.
3. Use a hexagonal screw, flat washer, and spring pad, and fix the massager on the fixed piece on the upper end of the supine support.

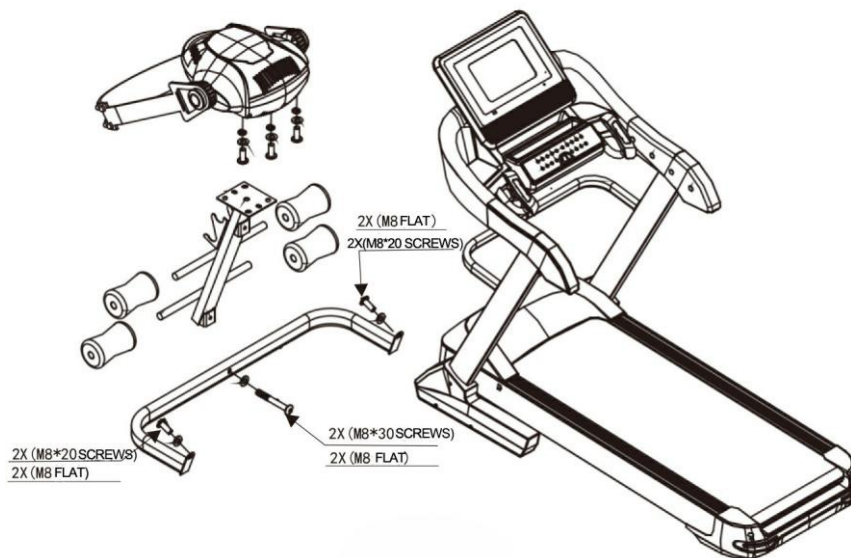

ASSEMBLING OF OTHER COMPONENTS

1. Place the dumbbell on the card slot on the seat in picture.
2. The twister can be placed in a stable position.
3. The security lock is placed on the electronic meter dot.
4. The massage belt can be hung in the card slot on both sides of the massage machine head.

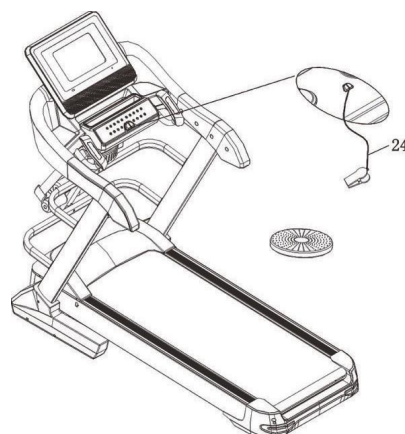

After all the accessories have been assembled, make sure all the screws are tightened before they can be used.

OPERATING INSTRUCTIONS

TREADMILL INSTRUCTIONS (operating instructions in manual mode)

1. Insert the power plug into the socket, turn on the power switch (the light will turn red), and a Sound "BI" will be produced. Then the screen on the panel will display.
2. Place the safety lock in the panel's yellow position, and the treadmill will be ready for use. Please clip the safety lock on the clothes to avoid accidents while running. You can pull out the safety lock at any time, and the motor will stop immediately to prevent you from falling. Every time the equipment is used, please place the safety lock back to the Yellow dot on the screen.

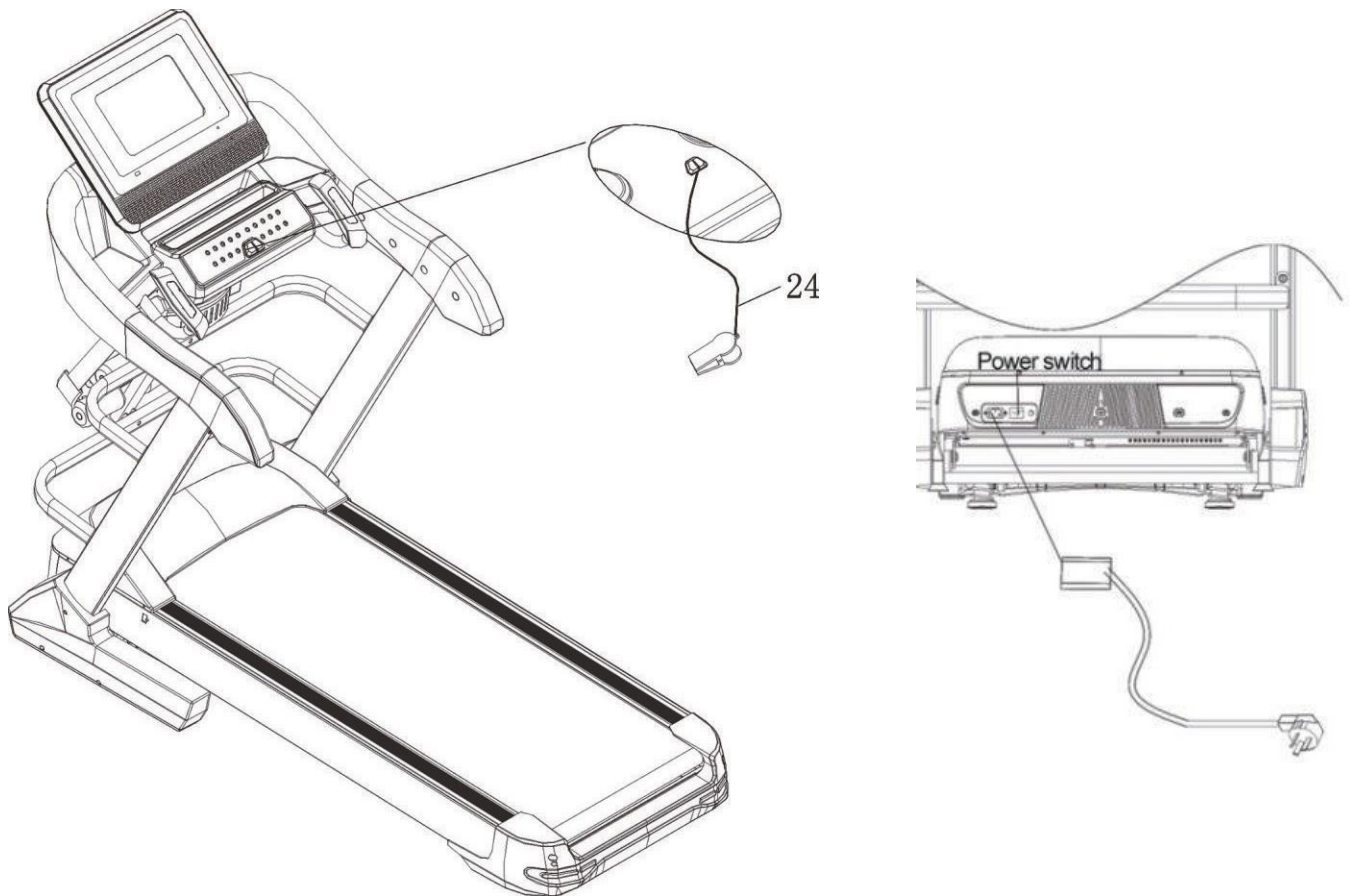

When using a treadmill, you must use a power outlet with a grounding wire for your safety.

MASSAGE MACHINE AND OTHER FEATURES

When using a massage machine, you must use a power socket with grounding wires for your safety.

1. When using the massage machine, please do not fold up the main frame A of the platform, avoid tipping forward as a whole when you massage.
2. If required ,you can lie down on the main frame A and do sit-ups.

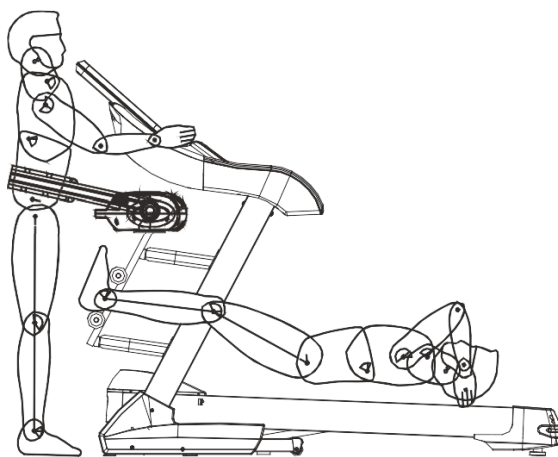

MOVEMENT INSTRUCTIONS OF TREADMILL

1. When you fold the treadmill, use your feet to fix the side of the base, and pull the armrests back with your hands to tilt the machine backwards.
2. After folding the equipment, place it in a safe zone where children do not play around in order to prevent the children from hitting the equipment,causing the running platform to fall and bruise, resulting in damage to the machine.

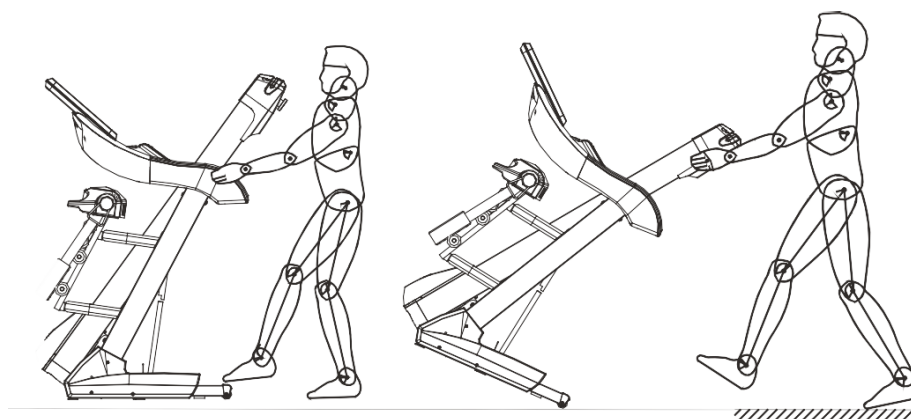

FOLDING INSTRUCTIONS OF TREADMILL

1. Folding treadmill: before folding, turn off the power switch, unplug the power line, and slowly lift the running platform by hand until the running platform is caught by the gas spring casing
2. Put down the running platform: as shown in the figure, use the foot to lightly press the gas spring casing, and the running platform will slowly land on the ground.

LIFT THE RUNNING PLATFORM

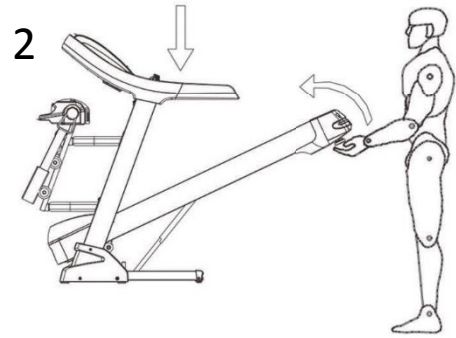
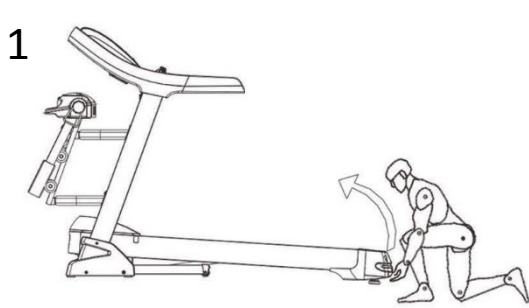

PUT DOWN THE RUNNING PLATFORM

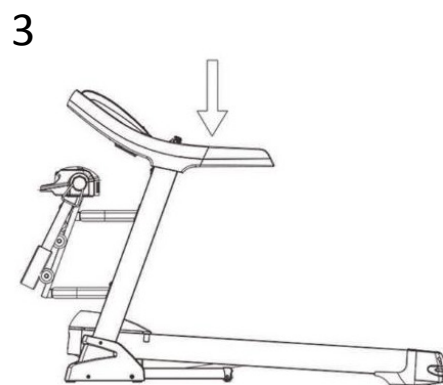
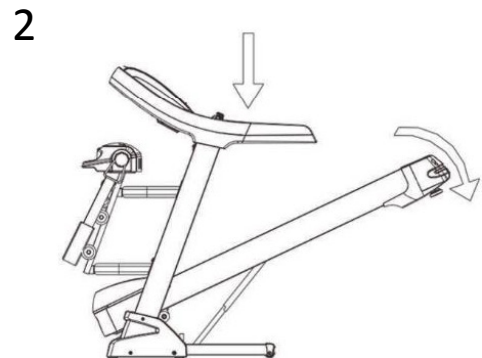
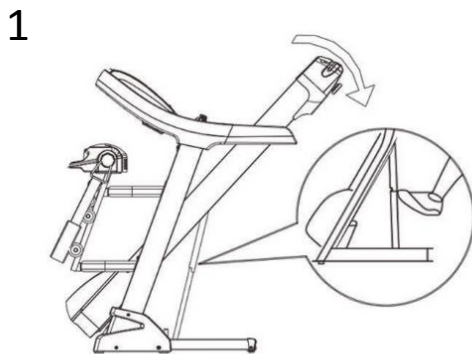

PANEL INSTRUCTIONS

- 1. USB Interface:** after the operation, the system plays songs or videos in the USB storage.
- 2. MP3 Interface:** insert MP3 audio, the speaker can play MP3 music.
- 3. “3%,6%, 9%, 12%” Incline Shortcuts:** set the slope quickly.
- 4. “4, 8, 12, 16” Speed Shortcuts:** set the speed quickly.
- 5. Volume Plus Minus:** increase or decrease the volume.
- 6. Incline/Decline Button:** incline and decline shortcuts: incline range:0-15%.The adjustment range is one segment/time, and when continuously pressed for more than 0.5 seconds, the machine automatically and continuously inclines/declines.
- 7. Home Button:** return directly to the main interface from any sub-interface
- 8. Start Button:** the treadmill can be started at any time by pressing this button with the power on and the safety lock engaged. The treadmill starts at the lowest speed and the lowest slope if it is started in manual mode.
- 9. Stop Button:** this button can be used to stop the treadmill and reset it to zero during exercise.
- 10. Return Button:** can return to the previous interface.
- 11. Speed Range Shortcuts:** speed range: 1.0-18.8km/h adjustment range is 0.1km/time, and when continuously pressed for more than 0.5 seconds, the machine automatically and continuously increases/ decreases.

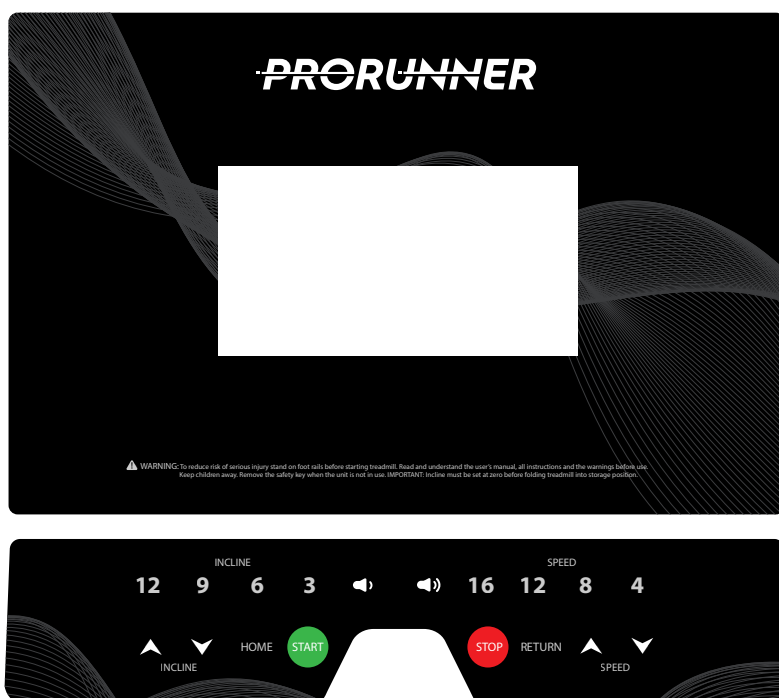

PRECAUTIONS

- To ensure the proper performance of the device, please do not download any APP to the system.
- Please clean up the operation on the device periodically.
- Please try not to use third-party apps. When exiting a third-party app, please use the return key first.
- WIFI restrictions, this product can not link WIFI, which requires verification of WIFI web page.

OPERATION DURING EXERCISE

- Treadmill will decelerate to stop running after pressing the “stop” button during exercise.
- Treadmill will display heart pulse data in about 5 seconds after the athlete holds the handle pulse with both hands.
- The key exercise for athletes is to warm up before running and slow down before totally stopping.
- Usually, the athlete walks slowly for 5 minutes and then fast walks or runs, and finally runs slowly for 5 minutes before stopping.

Explanation: When starting to run, set the speed slowly and walk for 5 minutes. This is roughly equivalent to the state of walking, and then gradually increasing the speed of the treadmill. When the speed increases to “5” or “6”, you are walking or jogging. Based on this state, the body has been basically adapted, you can maintain or increase the speed and slope according to your own needs, then officially run for about 20 minutes, and finally set to a slower speed, slow down for 5 minutes as a relaxation, let the body gradually adapt during exercise. This takes about 30 minutes at a time.

Usually, about 30 minutes of exercise has a better exercise effect, for ordinary exercisers, each run time should not exceed 60 minutes, too long exercise time may cause excessive fatigue.

INCLINE OPERATION DURING RUNNING

If you need to set the incline, set it to “0” when you start running. After 5 minutes of slow walking, when the body warms up, gradually increase the slope as needed, which can consume more calories, but the maximum slope is not suitable for long-running.

HEART RATE MONITORING WHILE RUNNING

Please do not get down from the treadmill immediately after running. When running, the body’s blood is mainly concentrated in the lower limbs. The rhythmic contraction of the muscles can help the blood of the lower limbs to return to the heart. However, if you stop immediately after running, the effect of this squeeze suddenly disappears, and the speed of blood returning to the heart slows down, which may cause insufficient blood supply to the brain. In serious scenarios, it may also cause shock symptoms.

THE TREADMILL HAS A HEART RATE MONITORING FUNCTION

You can assess whether to stop running by measuring the heart rate. Hold the hand pulse with both hands and display the heart pulse data in about 5 seconds. The treadmill will automatically calculate the heart pulse of your exercise. Generally, the heart pulse rate drops below 120, and it is basically OK.

BOOT SCREEN

QUICK START

1. Turn on the power switch and place the safety lock on the safety lock position on the panel.
2. After starting, the screen displays the main interface.
3. Press the “start” button on the panel, the treadmill will start running at the lowest speed and the lowest slope, and then you will need to press the incline button or speed button to change the slope and speed.

OPERATION DURING EXERCISE

- When the treadmill is running, press the stop button and the treadmill will decelerate to stop running.
- When the athlete holds the heartbeat handle with both hands, the heartbeat data is displayed in about 5 seconds.
- The key to the movement of the treadmill is the relaxation in the early stage and the slow stop after the exercise.
- Usually, walk slowly for 5 minutes and then go fast or run, and finally walk 5 minutes to finish running.

Explanation: When running, set a slower speed and walk for 5 minutes. This is roughly equivalent to the state of walking, and then gradually increasing the speed of the treadmill. When the speed increases to “5” or “6”, you are fast walking or The state of jogging, the body has basically adapted at this time, you can maintain or increase the speed and slope according to your own needs, then officially run for about 20 minutes, and finally set to a slower speed, slow down for 5 minutes as a release Loosen the body and let the body gradually adapt to the movement. This takes about 30 minutes at a time.

- Usually, 30 minutes of exercise has a good exercise effect, for every runner who runs. The time should not exceed 60 minutes. Excessive exercise time may cause excessive fatigue.
- During the exercise, the lift setting (Some models do not have a lift function, this function is for reference only, subject to the actual product)
- If you need to set the lift (slope), set it to “0” when you start running. After 5 minutes of slow walking, after the body adapts, gradually increase the slope as needed, which can also consume more calories, but the maximum slope level is not suitable for long-running.
- Heart rate monitoring during running.

- Please don't get down from the treadmill immediately after running. The blood of the body is mainly concentrated in the lower limbs when running. The rhythmic contraction of the muscles can help the blood of the lower limbs to return to the heart. However, if you stop immediately after running, the effect of this squeeze suddenly disappears, and the speed of blood returning to the heart slows down, which may cause insufficient blood supply to the brain. In severe cases, there may be shock symptoms.
- The treadmill comes with heart rate monitoring, which allows you to assess your heart rate by measuring your heart rate at the end of your run. Hold the heartbeat handle with both hands and display the heartbeat data for about 5 seconds. The treadmill will automatically calculate the number of real-time heartbeats for your exercise. Generally, the heart rate drops below 120, which is basically enough.

START UP SCREEN



QUICK START

1. Turn on the power switch and properly attach the magnetic safety lock to the safety lock position below the panel.
2. Press the "Start" button on the panel to start the system;
3. After startup, the screen displays the main interface;
4. Press the "Start" button on the panel at this time, the treadmill will start at the lowest speed and the lowest slope; press the "incline + -" or "speed + -" button to change the slope and speed as needed.









Main Interface





The main interface is divided into eight functional modules: local audio and video, internet, program motion, real life motion, speed shifting motion, user center and system settings.

GESTURE OPERATION

	Swipe left and right	Single finger press and hold and slide left and right on the screen. This operation can switch between the eight function modules on the main interface.
	Slide up and down	Single finger press and hold, and slide up and down on the screen. When the interface has a list menu, this action can be swiped up and down to view the content.
	Click	A single finger on the screen, a quick single click on the screen. When you click an icon, it will enter the function interface.



ICON	FUNCTION DESCRIPTION	ICON	FUNCTION DESCRIPTION
	User avatar and name: user can modify user name and avatar		Volume button: adjustable volume mainly suitable for music and video playback interfaces.
	Back button: can return to the previous interface. (except main interface)		Home button: return the main screen from any interface. (except main interface)
	WiFi icon: used to check if the system is connected to the WiFi network.	0:03	Time display: convenient for sports people to view time.
	Start button: click this icon at any time, the system will enter "3,2,1, GO" and treadmill will start running. You can hold this icon and let go, move the icon to another place.		System settings: built in brightness adjustment, WiFi management, factory mode, clean cache, machine management and other five functions.
	local audio and video: Used to manage system memory and audio and video files in an external USB flash drive.		The Internet: built in third party music app, third party video app, internet, social, news

ICON	FUNCTION DESCRIPTION	ICON	FUNCTION DESCRIPTION
	Program movement: there are 8 kinds of sports modes built in and divided into 2 categories. Time countdown mode, Distance countdown mode, Calorie countdown mode, Body shaping running, fat burning running, Mountain running, Road running, Heart rate control speed running.		Real life movement: there are three kinds of real life sports in the Gobi, grassland and seashore. (Different models may be added or deleted)
	Speed matching movement: built in full horse running, half horse running, 3km, 5km, 10km, 15km, a total of 6 speed modes.		User center: personal information, sports data management

FUNCTION DETAILS

LOCAL AUDIO AND VIDEO

Used to manage and play back the audio and video files in the system memory and external U disk.



- Supports playback of common audio and video format files such as MP3, APE, MP4 and MOV.
- The audio and video files in the local audio and video are connected to the network without being connected to the network.
- During the exercise you should try to use music with fast rhythm. It is best to adapt to the rhythm of the running. Suddenly the music with large rhythm changes easily has an adverse affect on the rhythm of running.
- Please try not to watch the video while running, which is easy to distract and may cause the speed to run too fast or too slow.

HOW TO STORE AUDIO AND VIDEO LOCALLY

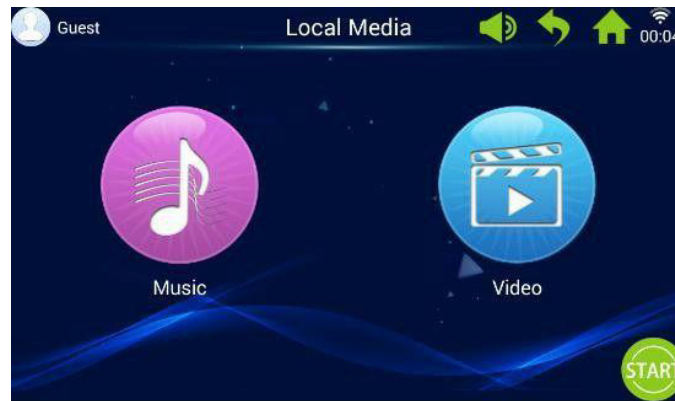

1. Insert the USB storage device into the USB interface and copy or play the audio and video files through related operations.
2. After connecting to WIFI, play it with every three-party music or video app of the Internet; Click the local audio and video icon to enter the local audio and video interface.

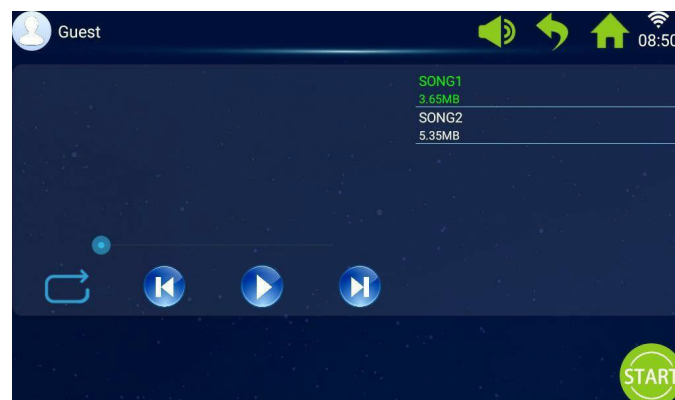

MUSIC INTERFACE

1. In the local audio and video interface, click  enter the music interface.
2. Swipe up and down to browse for the song name in the song list on the right.
3. Click on the song file to start.



SONG 18.36MB	Green indicates that the song name and size are playing white to indicate the song name and song size to be selected.		
	Start playing music		Play in the order of the song list
	Pause music		Random play of the song list
	Play the previous song		Single loop
	Play the next song		Move the progress bar dot left and right, can change the progress of the music

VIDEO INTERFACE

1. In the local audio and video interface, click  enter the music interface.
2. Swipe up and down to browse for the song name in the song list on the right.
3. Click on the video file to start playback.



CONTROL DIRECTORY

	Start playing video		Click to play the video, then achieve full screen effect, click again to exit full screen
	Pause video		
	Play the previous video		
	Play the next video		Show video thumbnails, video name, and video size
	Move the progress bar dot left and right, can change the progress of the video		

THE INTERNET

Built-in third-party music and video app, internet, social, news, and more.



- All applications in the Internet need to be connected to the WIFI network to use.
- Supports playing common audio and video format files such as MP3, APE, MP4, and MOV.
- Please try not to browse the web content or watch video files while running, so it is easy to be distracted and cause accidental injury; you can set up the content before starting the treadmill.
- Listen to some relaxing music during the running process to reduce the boring feeling during exercise.

Click  Internet Icon, enter the internet interface.



Click the Icon to open the app.

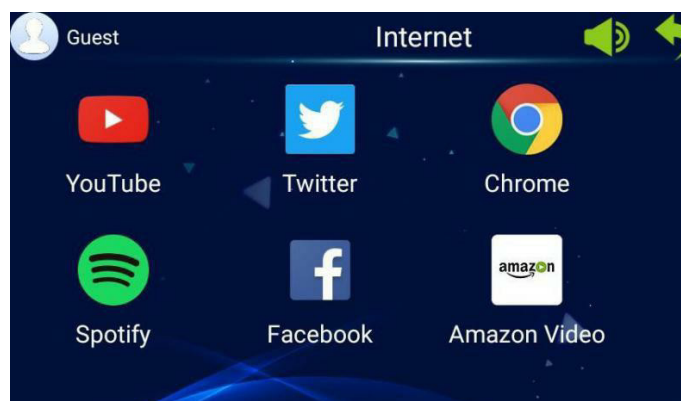

PROGRAM MOVEMENT

The eight built-in program sports modes are divided into two categories: time countdown mode, distance countdown mode, calories countdown mode; body sculpting, fat burning, mountain running, road running, and heart rate speed control.







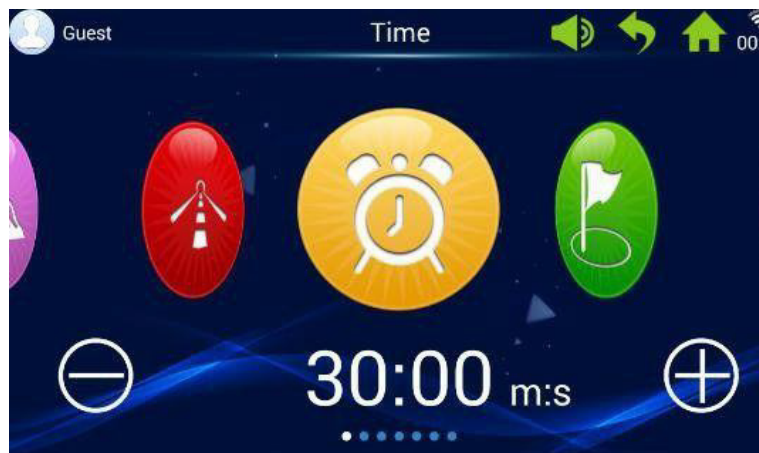

- Be sure to check if the safety lock is valid before exercising. Any abnormal situation occurred during the exercise, the safety lock was pulled off and the running opportunity quickly decelerated to stop running.
- Please pay attention to your heart rate value during the exercise. The highest heart rate is controlled at 220 minus the age (this is the limit value, the general exercise does not exceed 90% of this value) If it is an older exercise every minute the number needs to be lowered again.
- Any vigorous exercise please take about 30-60 minutes after meals.

Click  Program Sports Icon, enter the program sports interface.







Swipe left and right to switch between modes, click + or - to adjust the moving target.

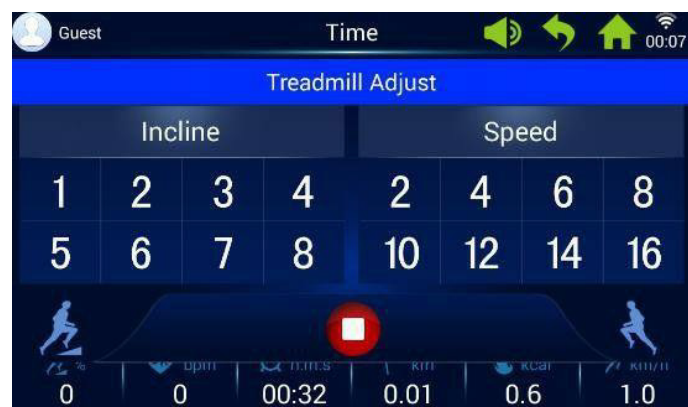
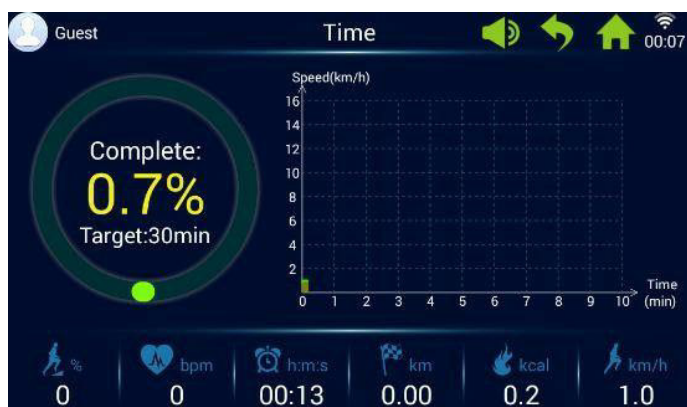

3 COUNTDOWN MOTION MODES			5 PROGRAM SPORTS MODES				
							
Time countdown mode	Distance counting mode	Calories countdown mode	Body sculpting	Fat burning	Mountain running	Road running	Heart rate control

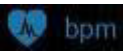
COUNTDOWN OPERATION EXAMPLE (time countdown mode)



	<p>Ring Chart: shows the user-set target distance and the current percentage completed.</p>
	<p>Coordinate Diagram: the abscissa indicates the current movement time, and the ordinate indicates the current running speed.</p>
	<p>Slope: displays the current slope value. For the adjustable range, see <Key Panel Description></p>
	<p>Heart Rate: shows the real-time heartbeat value of the athlete; when holding the heartbeat sensor handle with both hands, The system can automatically detect the heartbeat frequency of the athlete and display it at the heartbeat value range: 50-200 beats/min. (This data is for reference only and cannot be used as medical data)</p>
	<p>Time: shows current exercise time</p>
	<p>Distance: shows current mileage</p>
	<p>Calories: shows the calorie value of current exercise consumption</p>

STARTUP OF THE COUNTDOWN MODE

1. By sliding the interface left and right, select one of the three countdown modes; adjust the desired moving target. Press the start button, the treadmill will automatically count down after entering “3, 2, 1, GO”.

2. During the movement, you can use the speed of the panel and the slope key or floating window (in the countdown mode page, press any one of the places to pop up the treadmill parameter adjustment interface, the user can adjust the treadmill speed/slope according to his own situation) To adjust the speed and slope.

3. Press the stop button and the treadmill will decelerate to stop running.

BODY SCULPTING	NUMBER OF SEGMENTS	1	2	3	4	5	6	7	8	9	10	11	12	13	14	15	16
	SPEED	3	6	7	8	9	10	9	8	8	9	10	9	8	7	6	3
	SLOPE	0	2	2	4	4	4	2	2	2	3	3	4	4	3	2	1
FAT BURNING	NUMBER OF SEGMENTS	1	2	3	4	5	6	7	8	9	10	11	12	13	14	15	16
	SPEED	5	7	9	9	11	8	8	10	10	8	10	8	6	5	4	3
	SLOPE	3	5	4	4	3	5	5	3	3	5	3	5	5	3	3	3
MOUNTAIN RUNNING	NUMBER OF SEGMENTS	1	2	3	4	5	6	7	8	9	10	11	12	13	14	15	16
	SPEED	3	4	6	5	3	5	6	4	5	6	7	6	8	6	5	3
	SLOPE	6	8	10	12	14	12	10	14	12	10	8	10	6	4	3	2
ROAD RUNNING	NUMBER OF SEGMENTS	1	2	3	4	5	6	7	8	9	10	11	12	13	14	15	16
	SPEED	3	6	7	7	8	9	9	1	1	1	9	9	8	6	4	3
	SLOPE	1	1	2	2	3	3	3	2	2	2	3	3	2	2	1	1

ACCESSORIES - SPORTS PROGRAM DATA

Program Running Example: (road running)



	<p>Ring Graph: shows the user-set target time and the current percentage completed</p>
	<p>Column Chart of Speed and Slope: The abscissa indicates the number of segments, and each program is divided into 16 segments, and each segment of exercise time = set time / 16. The ordinate indicates the running speed and slope of each segment, representing the speed representing the slope.</p>

START OF PROGRAM MOVEMENT

1. Select the appropriate program, adjust the desired moving target, press the start button to start.
2. When entering the next block, the speed and slope of the treadmill will change with the block change after running a program, the treadmill will slow down and stop running.
3. The system will automatically calculate the results of the exercise and pop up the relevant transcript interface.



ACCESSORIES - SPORTS PROGRAM DATA

Program Running Example: (heart rate control speed running)

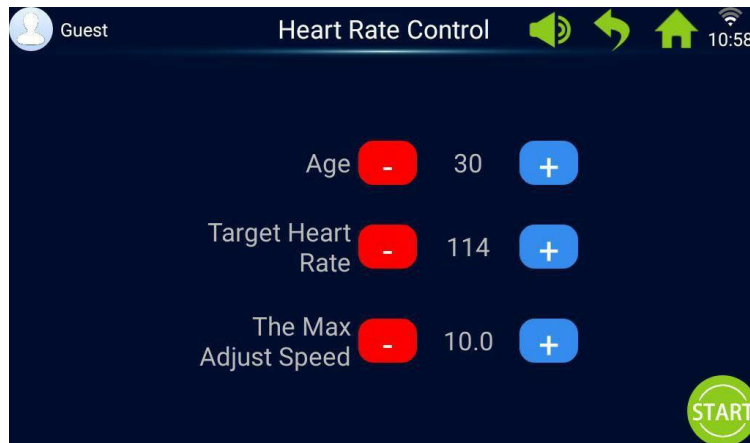

START OF HEART RATE SPEED CONTROL

1. Click the heart rate control icon to enter the motion parameter selection interface of the above figure, adjust the desired moving target, the maximum speed adjustment range of heart rate control speed: 3.0 (metric) / 2.0 (imperial) - maximum speed, default 10.0 (metric) / 6.0 (Inch), press the start button to start.
2. After starting, the slope is 0, the lowest speed, the first 1 minute is warm-up movement, the speed and slope can be adjusted manually. After the warm-up exercise, the speed and slope of the treadmill will change with the heart rate value; after running the target time, the treadmill runs smoothly and stops running.
3. The system will automatically calculate the results of the exercise and pop up the relevant transcript interface.

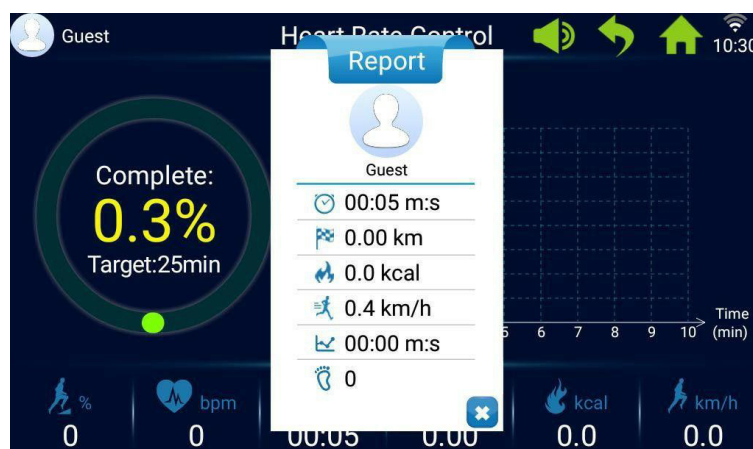

SPEED MOVEMENT

Built-in full-horse running, half-horse running, 3 km, 5 km, 10 km, 15 km 6 kinds of speed mode.



- When you are running fast, if you need to set the speed or slope value, you should use the speed and slope shortcut keys on the panel as much as possible to prevent the operation error of the finger when sliding the screen, and cause accidental injury.
- Different preset running modes, the corresponding training intensity is different; users should first confirm whether their current physical state can withstand or can be adequately trained, so as to avoid damage to the body due to excessive exercise or insufficient strength And the exercise effect on the treadmill is reduced;
- When running, you should stand in the middle of the running belt. Don't be too far forward or too late. If you are too late, you may be run out of the treadmill.

Click  Speed Control Sports Icon, enter the program sports interface.

Swipe left and right to switch between modes, click + or - to adjust the moving target.

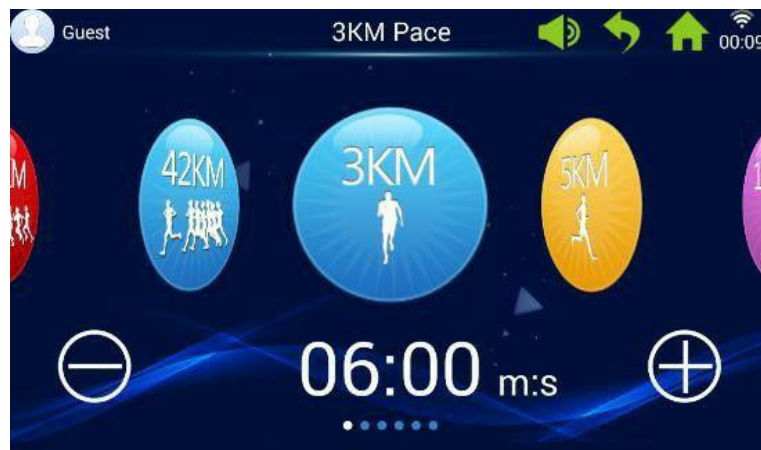

6 SPEED MODE					
					
Full marathon	Half marathon	3km running	5km running	10km running	15km running

ACCESSORIES - SPORTS PROGRAM DATA

Program Running Example: (full marathon)



	<p>Ring Chart: shows the target distance and the current percentage completed.</p>
	<p>Display target speed display Current speed display Average speed.</p>

- This interface displays various real-time parameters of motion. In addition to the data bar, the ring graphs of different colors display the user's pace and distance data in real-time.
- Press the stop button, the treadmill will slow down and stop running. The system will automatically calculate the results of the exercise and pop up the relevant transcript interface.

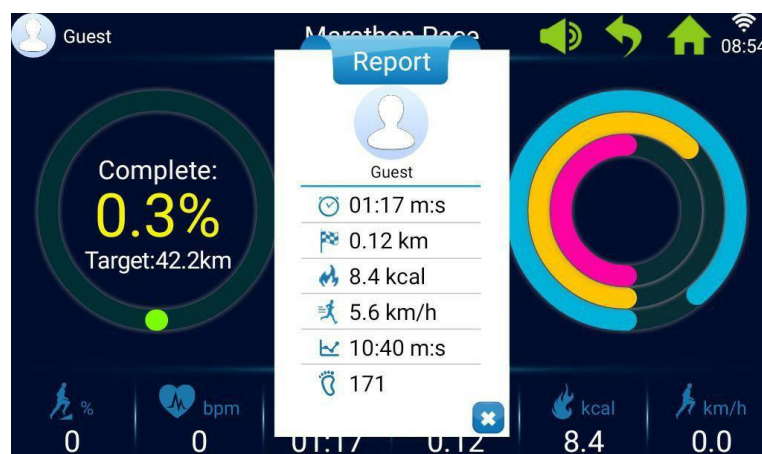

REAL MOVEMENT

There are three kinds of real-life sports in the Canyon, Grassland, and Seaside.
(Depending on the model, there may be additions and deletions)



- The user can set the real scene sports scene according to his own preferences, so that the movement process is not boring, and there is an immersive feeling.
- It is not advisable to exercise vigorously under fasting conditions.
- Listen to some relaxing music during the running process to reduce the boring feeling during the exercise.
- The length of exercise should not exceed 60 minutes.

Click  Real Life Sports Icon, enter the real life sports interface.

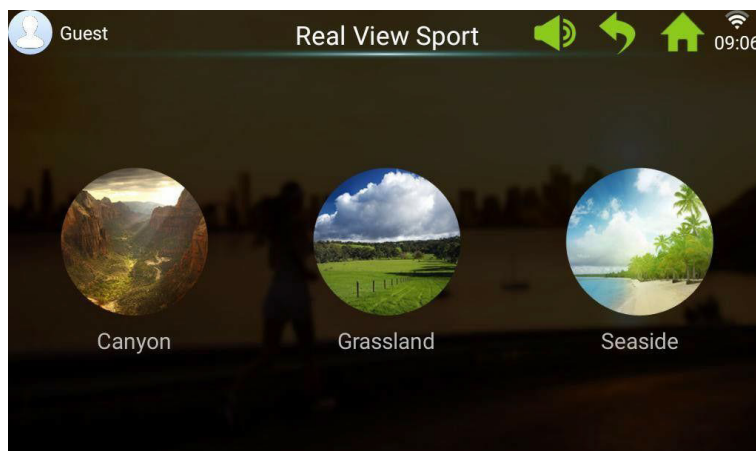



REAL MOVEMENT

In the live sports interface click  to enter the beach page.



Display the motion parameters during running at the bottom of the beach front running interface.

Click the  icon to hide the bottom motion parameter bar.

Click  to show the motion parameter bar.



USER CENTER

Users can manage personal information and sports data in this interface.



- Press the “Start” button in the lower right corner to move it to anywhere. (this operation applies to any page)
- When registering, if you can't input Chinese, please select - System Settings - Factory Mode - Native Settings.
- Language and Input Method on the main interface to switch between Chinese and English input methods.

In the main interface, click  the User Center icon to enter the login and registration page.

- In this function module, the user can set personal information such as avatar, nickname, gender, height, etc.
- You can view the sports data of the day, and the system will automatically record the historical sports data such as the calories, time, steps and mileage of the movements consumed by the user each time;
- When the treadmill is connected to the network, the system will collect and upload the user's personal sports data, in order to calculate the user's ranking in the system, and list the leader board (this function will not reveal the user's personal information, only for internal ranking reference).

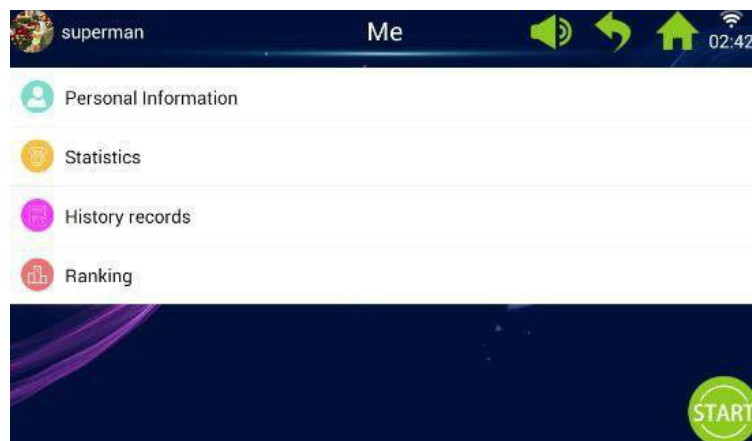

USER REGISTRATION

It is recommended that users register on the mobile terminal.

1. After confirming the password, press the “Finish” button.
2. Click “Register”, the following page will appear, fill in the registration information according to the steps in the figure.
3. After confirming the password, press the “Finish” button.
4. Click “Register new user” to complete.

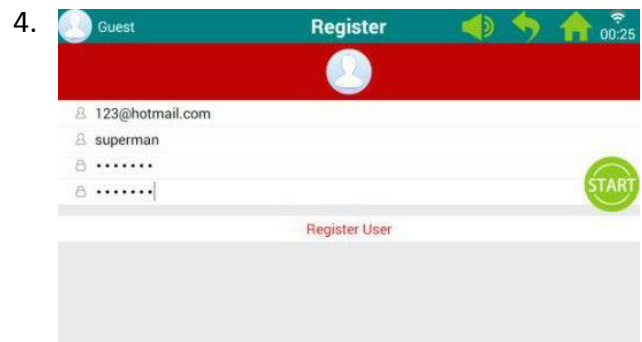
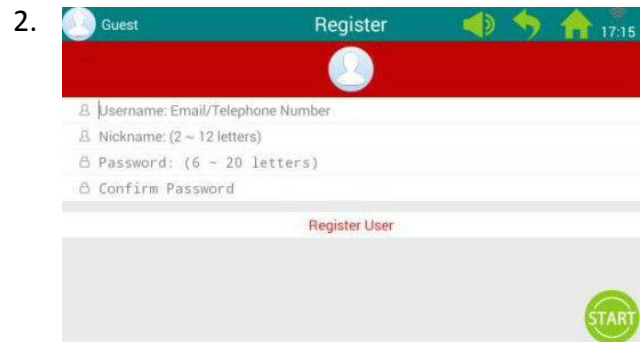
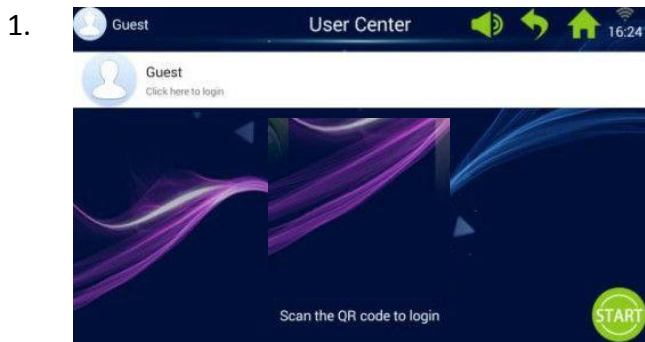

USER LOGIN

If it is a registered user, please log in directly.

1. Click the User Center icon.
2. Click on the “Guest” column at the top left of the interface. As shown below.
3. Enter your account number and password.
4. Click on “User Login.”
5. Successful login, enter the personal home page.

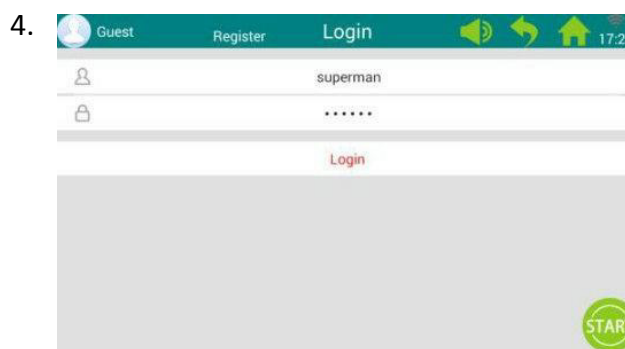
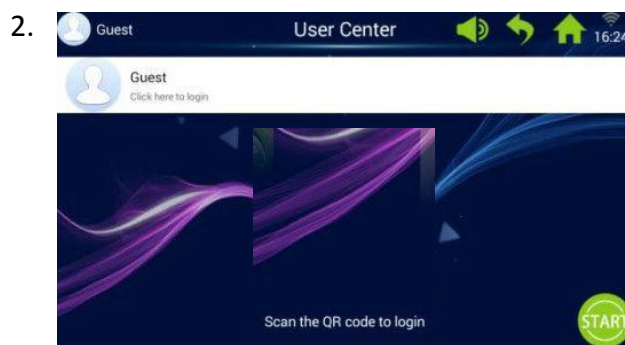

SYSTEM SETTINGS

Built-in brightness adjustment, WIFI management, factory mode, clean cache, machine management, and other five functions.



- You should not install too many APP apps on the treadmill at once, as this could cause the treadmill system to crash.
- Users will be unable to uninstall the built-in APP application.
- Please clear the data and cache of the APP application regularly.
- If the network cannot be successfully connected in System Settings - WIFI Management - the connection can be set in the WLAN in the - System Settings - Factory Mode - Native Settings - interface.

Click  System Settings icon to enter the System Settings page.



BRIGHTNESS ADJUSTING

In the system settings interface, click  to enter the leader board interface.



Slide the finger left and right on the brightness bar to increase the brightness and slide it left to decrease it.

WIFI MANAGEMENT

In the system settings interface, click  to enter the WIFI management interface.

CLEAN UP THE CACHE

In the system settings interface, click  to enter the cleanup cache interface.

On the right side of the cleanup cache interface, select the check box for the APP to clear the cache, and click the “Clean cache” button below to complete the cleanup.

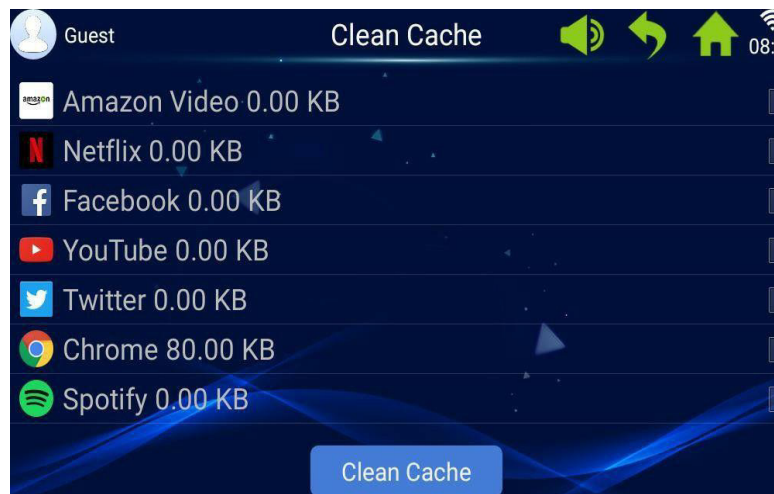

MACHINE MANAGEMENT

In the system setting interface, click  to enter the machine management interface. This interface displays the accumulated mileage and the mileage from the next maintenance.



ERROR REPORTING INTERFACE

Note: When the treadmill is used, if there is an abnormality, the interface will have an error message and a solution. (Some exceptions will not occur depending on the model)
DC motor reporting interface.

1. Communication Fail
2. Stall Protection
3. No Speed Signal
4. Ascension Learning Failed
5. Over Current Protection
6. Motor Open Circuit
7. Storage Error
8. Inversion Error
9. Instantaneous Over Current
10. External Voltage Over Voltage

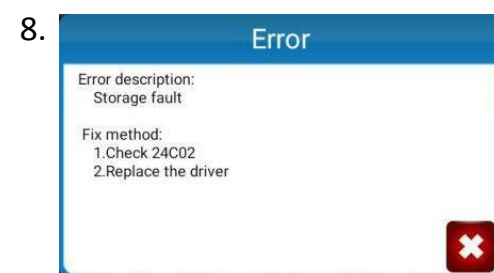
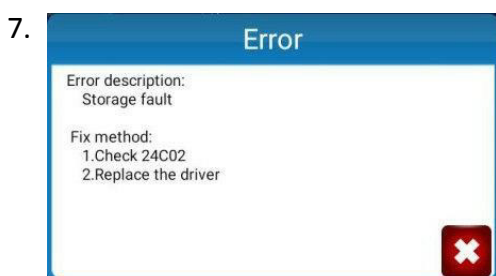
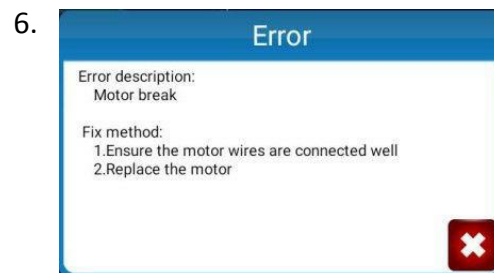
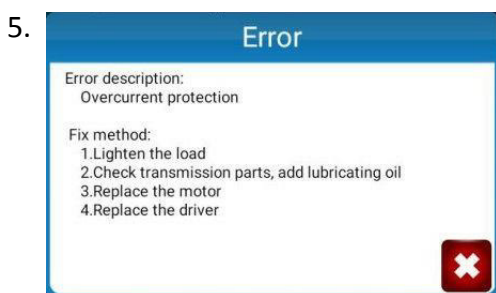
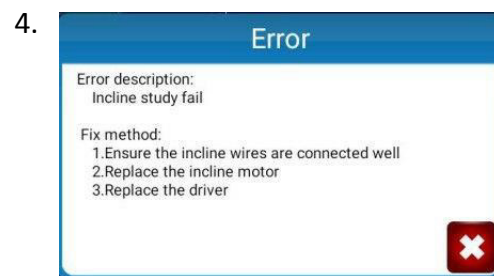
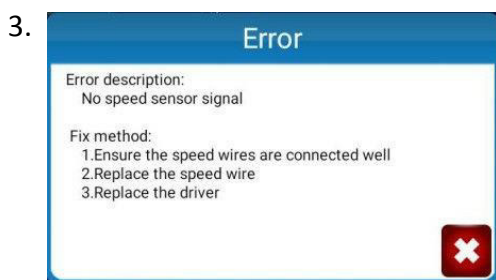
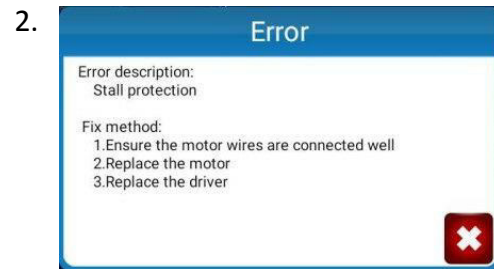
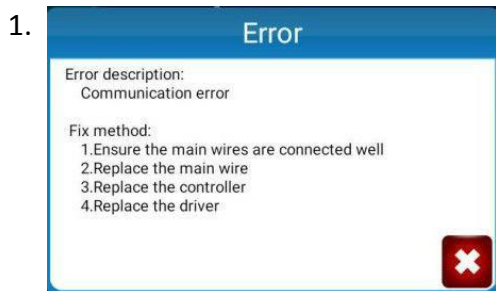

9. Instantaneous Over Current

10. External Voltage Over Voltage

REFUELING OIL PROCESS

HOW TO ADD FUEL TO THE TREADMILL?

1. Automatic Refueling

Fold the Frame at a 45° angle to drip the lubricating oil to the automatic fueling pipe. When the treadmill has run 50KM, it will automatically refuel once. No need to manually refuel. Users should pay attention to the oil in the oil bottle. If the oil is insufficient, the oil needs to be replaced.

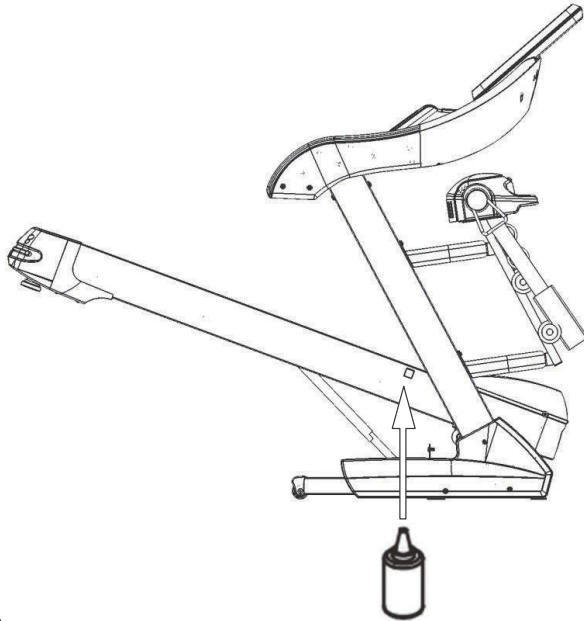

2. Manually Refueling

Open the fuel filler on the side of the treadmill as shown in the picture, pour the silicone oil into the fuel filler, and turn on the treadmill for a period of time after adding the oil.

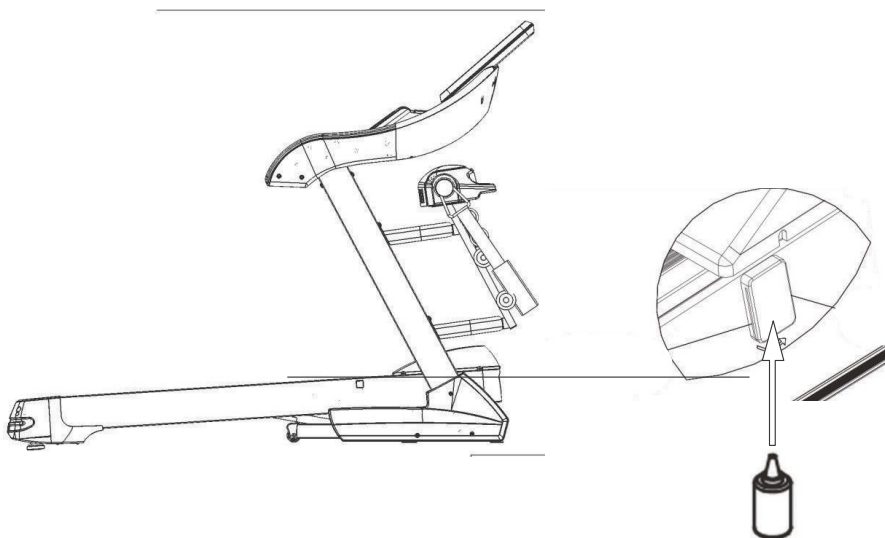

**Note: When refueling the running belt, the treadmill must be stopped and the running belt is at rest.
Proper maintenance is the only way to keep your treadmill at its best.
Wrong maintenance can hurt or shorten its life.**

RUNNING BELT ADJUSTMENT

RUNNING BELT ADJUSTMENT

- 1) Insert the 6 mm inner hexagonal wrench into the adjusting screw on the left side of the running belt and rotate the wrench clockwise for 1/4 turn to adjust the rear roller to tighten the running belt.
- 2) Repeat step 1 to adjust the right screw. It must be determined that the adjustment screw rotates the same distance so that the rear roller is adjusted parallel to the frame.
- 3) Repeat steps 1 and 2 until the running belt does not slip.

Note: The running belt can't be adjusted too tightly. This will break the running belt and increase the pressure of the front and rear rollers, causing problems such as roller bearing damage and abnormal noise. If you want to reduce the tension of the running belt, turn the wrench counterclockwise. Note that the left and right sides are rotated to the same distance.

ADJUST THE RUNNING BELT TO THE MIDDLE POSITION

In the case of walking on a treadmill, if the two feet don't use the same force, the pressure on the belt will be out of balance, and the belt will be out of alignment. This deviation is normal. When no one is on the running belt, it will return to the center. If it does not return to the center, you will need to adjust the belt back to the center.

HOW TO ADJUST THE RUNNING BELT TO THE MIDDLE?

- 1) Move the walking machine to no-load operation and adjust the speed to 6KM/H.
- 2) Observe the distance between the running belt and the left and right borders. For left deviation, use the inner hexagonal wrench and turn the left 1/4 screw clockwise. In the case of a right deviation, turn the 1/4 screw clockwise with the internal hexagonal wrench. If the running belt is still not in the middle, repeat the above action until it is adjusted to the middle.
- 3) After adjusting the running belt to the middle, adjust the speed to 1KM/H and observe the deviation of the running belt and whether there is slipping during running. If there is a deviation, repeat the steps mentioned above.
- 4) **WARNING! Do not over-tighten the rollers. This will cause permanent bearing damage. If the above steps are ineffective, you need to tighten the running belt again.**

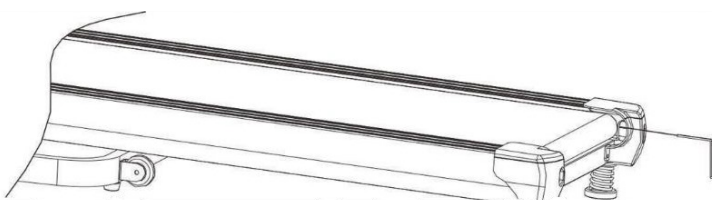

The Left and Right Elastic attachments are located behind the walking machine.

CLEANING

Frequently clean the treadmill to guarantee its service life.

Warning: Cut off the power when cleaning the treadmill. The power line must be pulled out from the socket.

After use: Clear sweat stains and sundries on the equipment and other parts with a clean towel and damp cloth.

Note: Don't use corrosive articles and liquid to prevent damage to electronic elements. Don't expose electronic elements to sunlight.

Every week: Clean the ground every week, and clear dirt brought by shoes and other sundries.

Storage: Please place your treadmill in a clean and dry environment, and ensure that the power is switched off and the plug is not in the power socket.

Movement and folding: Handling wheel is added to the design to move the treadmill. Please confirm that the power is off and the treadmill's body is folded before moving.

CONSIDERATIONS

WARNING

Please consult your doctor and receive a complete physical examination before using the product. Don't carry out frequent and violent exercises without a doctor's permission. Please stop using the product and consult your doctor if you feel unwell in use. The product shall be used correctly. Please read the service manual in detail before the exercise. Please keep children and pets away if the product is unattended or idle.

Please wear suitable clothes including sneakers. Please don't use loose clothes for exercise to prevent them from being hooked by the machine.

Ensure that all bolts and nuts are tightened when using the equipment. Regularly maintain the treadmill to keep it in good condition.

BEFORE USE

How to start an exercise plan depends on your physical condition. If you have not exercised for years or you are seriously overweight, you must gradually increase exercise time, such as a few minutes every week.

In the beginning, you may only exercise for a few minutes in the target heart rate scope. Anyway, your aerobic fitness will be improved in about 6-8 weeks. Don't get discouraged if it takes longer than you expected. It is vital to exercise at your own pace. Someday you will be able to exercise continuously for 30min.

Please consult your doctor before exercise or training. Ask the doctor to inspect your training and diet plan and suggest your exercise plan.

Set an exercise goal after consulting with your doctor to ensure that the plan is practical, and start an exercise plan at leisure.

You can add some aerobic exercises into your exercise plans, such as walking, jogging, swimming, dancing, or riding. Test pulse frequently. If you have no electronic heartbeat monitor, consult the doctor about how to correctly measure the pulse with the hand from the wrist or neck. In addition, you must set a target heart rate on the basis of age and physical condition.

Drink enough water during exercise. You must supplement water lost due to overexercise to prevent dehydration. Don't drink a great deal of ice water or beverages. The temperature of drinking water or beverage shall be room temperature.

These instructions are for reference only.